

# KATALOG 2020 | 21

svítidla & elektromateriál





## LED / ZÁŘIVKOVÁ SVÍTIDLA

5 - 44

LED / ŽIARIVKOVÉ SVIETIDLÁ



## MONTÁŽNÍ LAMPY

45 - 46

MONTÁŽNE LAMPY

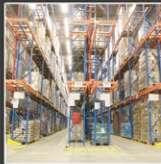

## TECHNICKÁ SVÍTIDLA

47 - 71

TECHNICKÉ SVIETIDLÁ



## BYTOVÁ SVÍTIDLA

72 - 83

BYTOVÉ SVIETIDLÁ



## REFLEKTORY

84 - 97

REFLEKTORY



## SVĚTELNÉ ZDROJE

98 - 112

SVETELNÉ ZDROJE

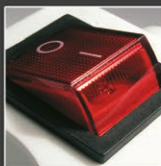

## ELEKTROMATERIÁL

113 - 134

ELEKTROMATERIÁL



## ZABEZPEČOVACÍ TECHNIKA

135 - 141

ZABEZPEČOVACIA TECHNIKA



## STOLNÍ LAMPY

142 - 147

STOLNÉ LAMPY



## STOJACÍ LAMPY

148 - 150

STOJANOVÉ LAMPY



## VENKOVNÍ SVĚTLA

151 - 160

VONKAJŠIE SVETLÁ



ZÁŘIVKOVÁ / LED TĚLESA  
ŽIARIVKOVÉ / LED TELESÁ



5

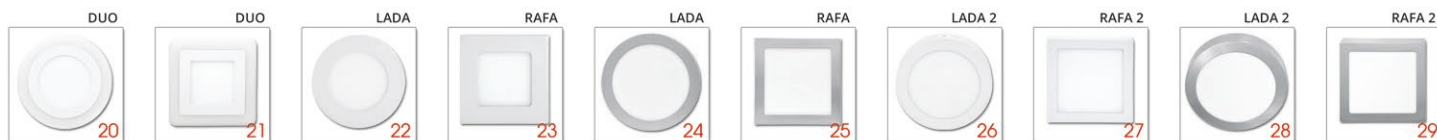

MONTÁŽNÍ LAMPY  
MONTÁŽNE LAMPY

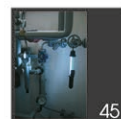

45



TECHNICKÁ SVÍTLIDLA  
TECHNICKÉ SVIETIDLÁ

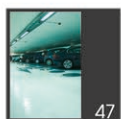

47

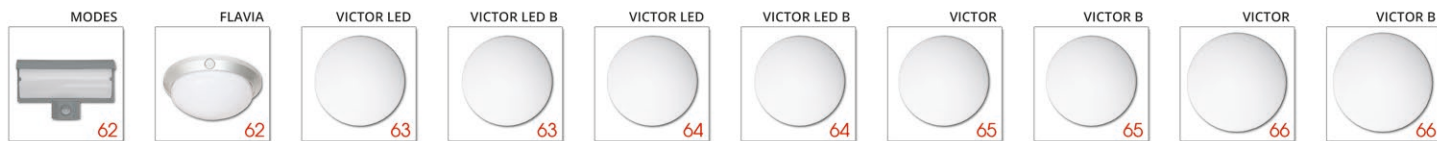

BYTOVÁ SVÍTLA  
BYTOVÉ SVIETIDLÁ

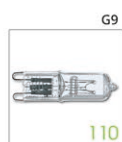
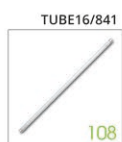
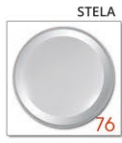

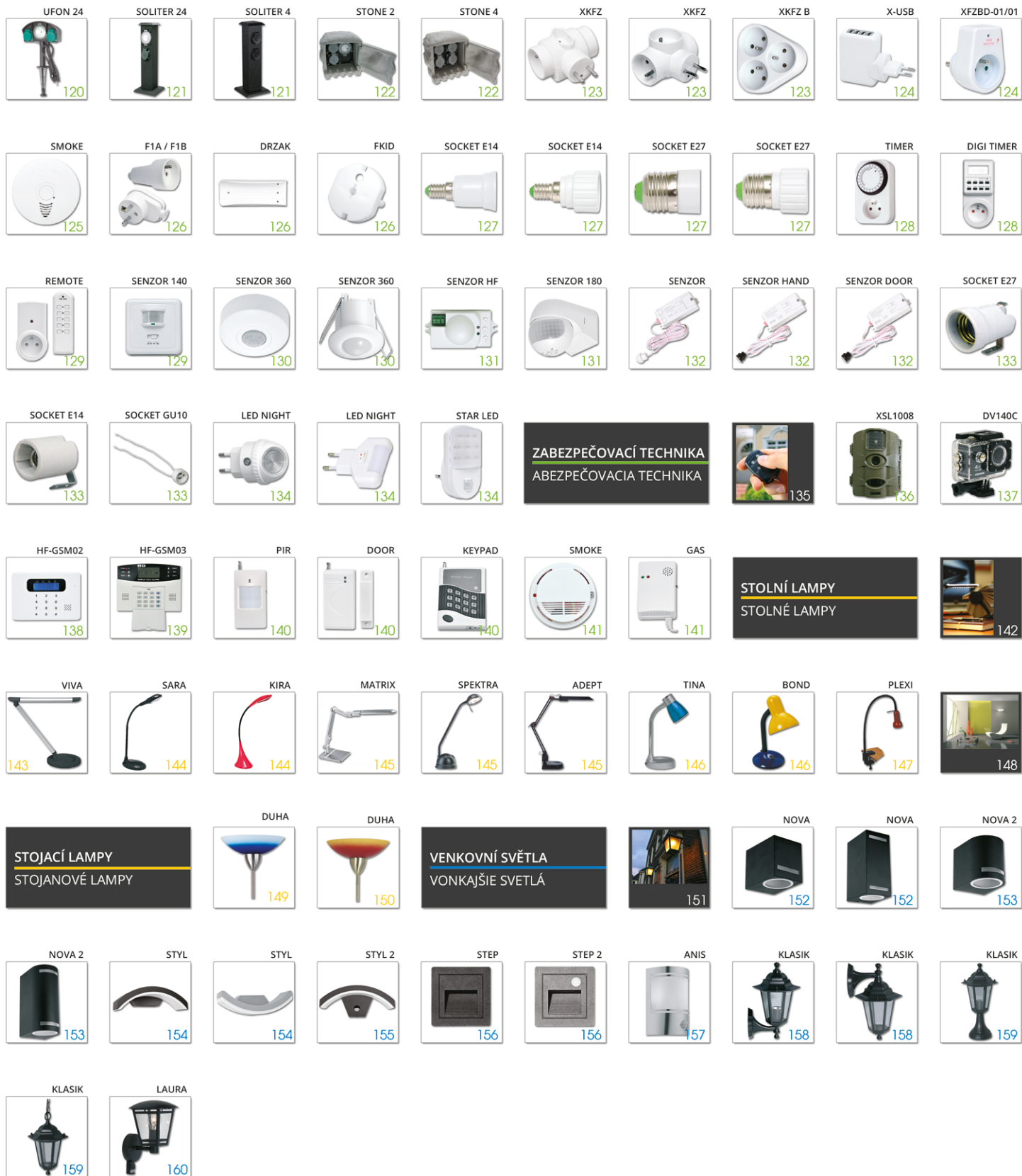

**LED / ZÁŘIVKOVÁ SVÍTIDLA**

LED / ŽIARIVKOVÉ SVIETIDLÁ





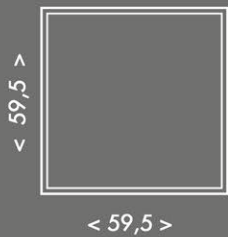

**Ecolite LED-EXTRA44-45**

Toto svítidlo obsahuje světelné zdroje LED.

**A++** LED

Světelné zdroje LED v tomto svítidle nelze vyměnit.

874/2012

**LED**



**45W 6000lm**



**LED-EXTRA44-45**



8 590 849 521 825

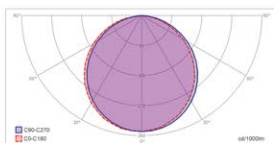

**LED-GPL44-EM**



Ize použít pro panely 45W detail na str. 12



CE	~230V	F	SMD chip	max. 45W
140°	IP20	30000h	4000K	
Ra ≥80				5

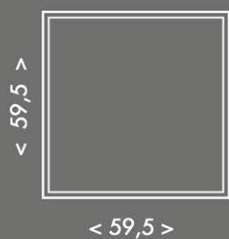

**Ecolite LED-GPL44-45**

Toto svítidlo obsahuje světelné zdroje LED.

**A+**  
**A**  
**A**  
**C**  
**D**  
**F**

**LED**

Světelné zdroje LED v tomto svítidle nelze vyměnit.

874/2012

**LED**



45W **4200lm**

**LED-GPL44-45/3000**



45W **4300lm**

**LED-GPL44-45**



45W **4400lm**

**LED-GPL44-45/6000**



**LED-GPL44-EM**



Ize použít pro panely 45W detail na str. 12

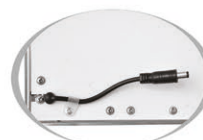
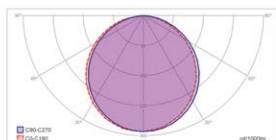

CE	~230V	F	SMD chip	max. 45W
140°	IP20	30000h	3000K	
4000K	6000K	Ra ≥80		
A	5			



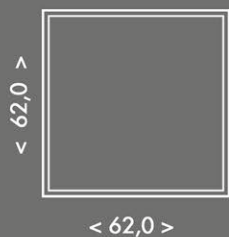

**Ecolite LED-GPL44-45/PD**

Toto svítidlo obsahuje světelné zdroje LED.

**A+**  
**A**  
**A**  
**C**  
**D**  
**F**

**LED**

Světelné zdroje LED v tomto svítidle nelze vyměnit.

874/2012

**LED**



60,5x60,5

**45W** **4300lm**



**LED-GPL44-45/PD**



8 590849 516838

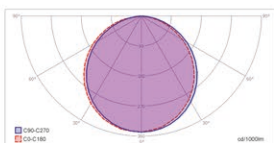

**LED-GPL44-EM**



Ize použit pro panely 45W  
detail na str. 12



	~230V		SMD chip	max. 45W
140°		IP20	30000h	4000K
Ra ≥80				

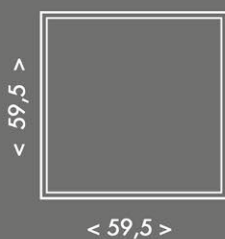

**Ecolite LED-GPL44-45**

Toto svítidlo obsahuje světelné zdroje LED.

Světelné zdroje LED v tomto svítidle nelze vyměnit.

874/2012

**LED**

**45W 4300lm**



**LED-GPL44-45**



8 590 849 516 821



**set 4ks**



8 590 849 516 869

**LED-GPL44-ZAVES**

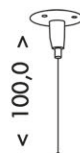

**LED-GPL44-EM**



Ize použít pro panely 45W  
detail na str. 12

CE	~230V	F	SMD chip	max. 45W
140°	IP20	30000h	4000K	
Ra ≥80	5			

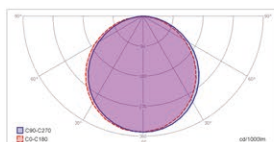





LED-GPL44-RAM

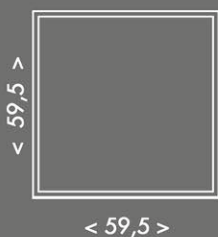

LED-GPL44-RAM/24



LED-GPL44-RAM/75



LED-GPL44-RAM/B



LED-GPL44-RAM



LED-GPL44-RAM/24



LED-GPL44-RAM/75



LED-GPL44-RAM/B





24W 29,5 x 59,5  
75W 59,5 x 119,5



**Ecolite LED-GPL44**

Toto svítidlo obsahuje světelné zdroje LED.

**A+**  
**A**  
**A**  
**C**  
**D**  
**F**

**LED**

Světelné zdroje LED v tomto svítidle nelze vyměnit.

874/2012

	~230V		SMD chip	max. 24W
max. 75W		140°		IP20
4000K	<b>Ra</b> ≥80			
	24W-10		75W-5	

## LED

24W **2300lm**

LED-GPL44-24

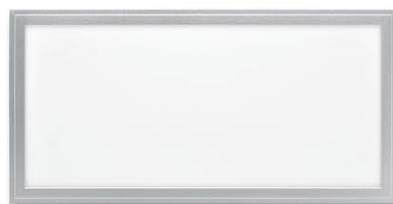

75W **7000lm**

LED-GPL44-75

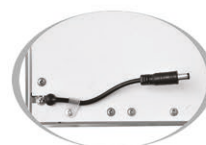
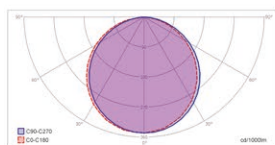

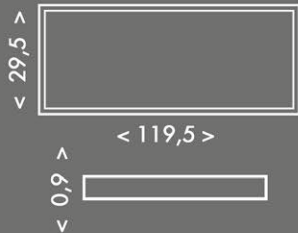

## LED

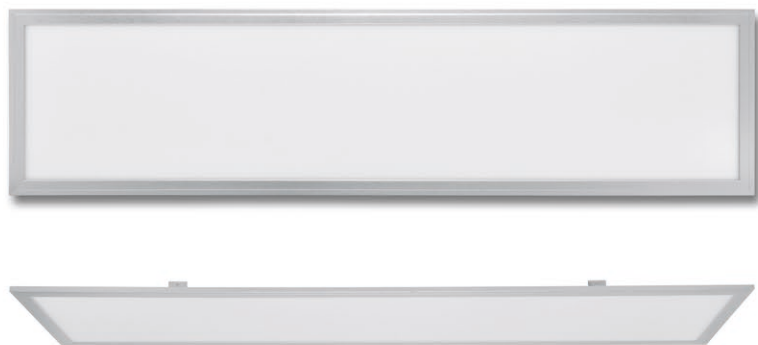

45W **4300lm**  
LED-GPL44/B-45

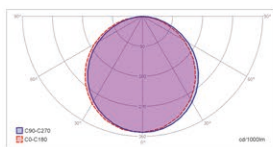

Ecolite LED-GPL44

Toto svítidlo obsahuje světelné zdroje LED.

A+  
A+  
A  
C  
D  
E

LED

Světelné zdroje LED v tomto svítidle nelze vyměnit.

874/2012

CE	~230V	F	SMD chip	max. 45W
140°	IP20	30000h	4000K	
Ra ≥80				

LED-GPL44-EM

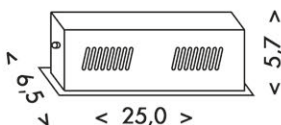

pouze pro panely 45W

LITHIUM ACCU	7.4V 4.5Ah	*max. 3h	760lm
--------------	---------------	-------------	-------



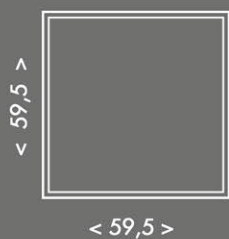

**Ecolite LED-GPL-50**

Toto svítidlo obsahuje světelné zdroje LED.

**A+**  
**A**  
**A**  
**C**  
**D**  
**F**

LED

Světelné zdroje LED v tomto svítidle nelze vyměnit.

874/2012

## LED



50W 4300lm



LED-GPL-50

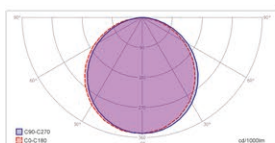

CE	~230V	F	SMD chip	max. 50W
140°	IP20	30000h	4000K	
Ra ≥80				4



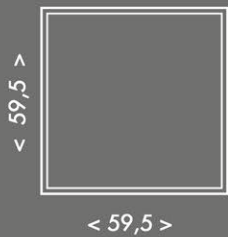

**Ecolite LED-GPL44-45/BI**

Toto svítidlo obsahuje světelné zdroje LED.

**A+**  
**A**  
**A**  
**C**  
**D**  
**F**

**LED**

Světelné zdroje LED v tomto svítidle nelze vyměnit.

874/2012

## LED



**45W 4300lm**



**LED-GPL44-45/BI**



8 590 849 5253 04



$< 5,0 >$

**LED-GPL44-RAM/BI**



8 590 849 5253 11

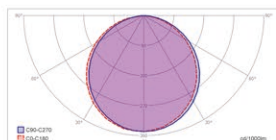

**LED-GPL44-EM**



Ize použit pro panely 45W detail na str. 12

CE	~230V	F	SMD chip	max. 45W
140°	IP20	30000h	4000K	
Ra ≥80				5



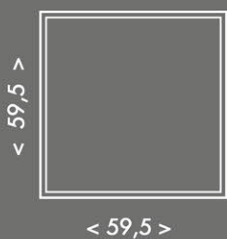

**Ecolite LED-GPL44-45/UGR**

Toto svítidlo obsahuje světelné zdroje LED.

**A+**  
**A+**  
**A**  
**C**  
**D**  
**E**

**LED**

Světelné zdroje LED v tomto svítidle nelze vyměnit.

874/2012

## LED



- Vhodné pro:**
- učebny
  - ordinace
  - projekční studia



**45W 4300lm**



**LED-GPL44-45/UGR**



8 590849 525915

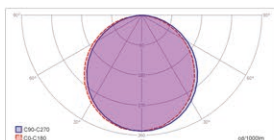

**LED-GPL44-EM**



Ize použít pro panely 45W detail na str. 12

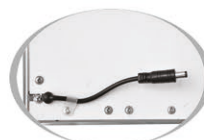

				max. 45W





## LED / ZÁŘIVKOVÁ SVÍTIDLA

### LED / ŽIARIVKOVÉ SVIETIDLÁ

NOVINKA  
LED

ROXY  
A+



6W - ø 7,5  
11W - ø 12,5  
22W - ø 18,5

6W **450lm**



Ø 5,5

LED-NR-6W/IP66

11W **890lm**



Ø 10,5

LED-NR-11W/IP66

22W **1840lm**



Ø 16,5

LED-NR-22W/IP66

LED-NR-6W/IP66



LED-NR-11W/IP66



LED-NR-22W/IP66





# LED / ZÁŘIVKOVÁ SVÍTLIDLA

## LED / ŽIARIVKOVÉ SVIETIDLÁ

NOVINKA

LED

BRIX  
A+



6W **470lm**



Ø 5,5

LED-NS-6W/IP66

11W **920lm**



Ø 10,5

LED-NS-11W/IP66

22W **1890lm**



Ø 16,5

LED-NS-22W/IP66

LED-NS-6W/IP66



8 590 849 15 265 23

LED-NS-11W/IP66



8 590 849 15 265 09

LED-NS-22W/IP66



8 590 849 15 265 16

< 1,0 ^

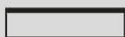

6W - 7,5x7,5  
11W - 12,5x12,5  
22W - 18,5x18,5

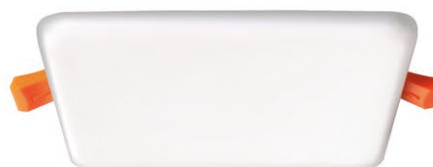





# LED / ZÁŘIVKOVÁ SVÍTIDLA

## LED / ŽIARIVKOVÉ SVIETIDLÁ

NOVINKA  
LED

VALI  
A+



18W 1550lm



LED-IN-18W

30W 2600lm



LED-IN-30W

LED-IN-18W



LED-IN-30W

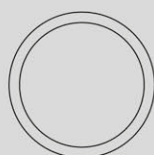

18W - Ø 22,5  
30W - Ø 33,0





# LED / ZÁŘIVKOVÁ SVĚTLA

## LED / ŽIARIVKOVÉ SVIETIDLÁ

NOVINKA  
**LED**

VALI 2  
A+

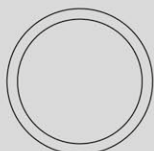

18W - Ø 22,5  
30W - Ø 33,0



< 1,9 >

18W **1550lm**



LED-IN-18W/HF

30W **2600lm**



LED-IN-30W/HF

LED-IN-18W/HF



LED-IN-30W/HF

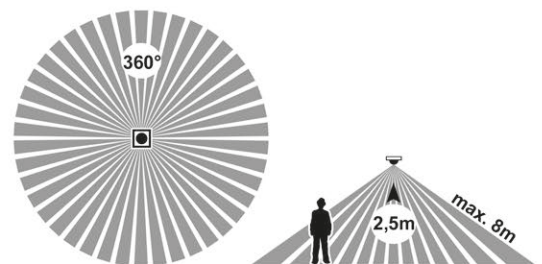

HF senzor detekuje pohyb i přes sklo a lehké stavební materiály.

HF senzor je nastaven výrobcem - nelze přenastavit



40sec



100lux





# LED / ZÁŘIVKOVÁ SVÍTLIDLA

## LED / ŽIARIVKOVÉ SVIETIDLÁ

NOVINKA  
LED

DUO  
A+

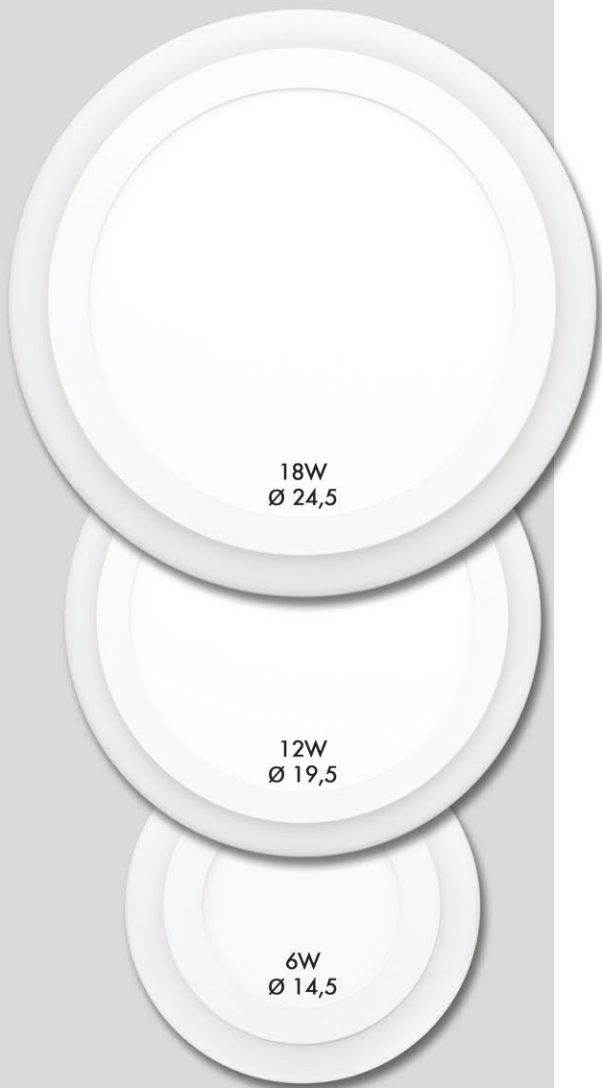

18W  
Ø 24,5

12W  
Ø 19,5

6W  
Ø 14,5



6W + 3W **400lm + 80lm**



Ø 10,5

LED-DUO-R6W

LED-DUO-R6W



85908491529029

12W + 4W **900lm + 100lm**



Ø 15,5

LED-DUO-R12W

LED-DUO-R12W



85908491529043

18W + 6W **1530lm + 160lm**



Ø 20,5

LED-DUO-R18W

LED-DUO-R18W



85908491529067







# LED / ZÁŘIVKOVÁ SVÍTIDLA

## LED / ŽIARIVKOVÉ SVIETIDLÁ

NOVINKA  
LED

DUO  
A+



6W + 3W **400lm + 80lm**



10,5x10,5

LED-DUO-S6W

LED-DUO-S6W



12W + 4W **900lm + 100lm**



15,5x15,5

LED-DUO-S12W

LED-DUO-S12W



18W + 6W **1530lm + 160lm**



20,5x20,5

LED-DUO-S18W

LED-DUO-S18W

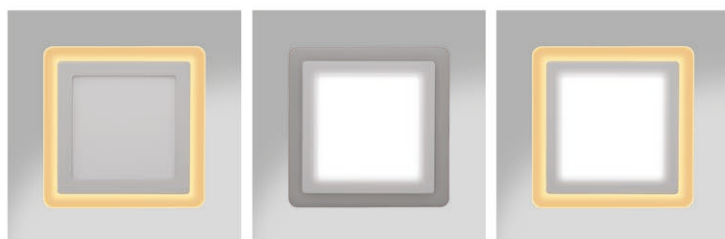
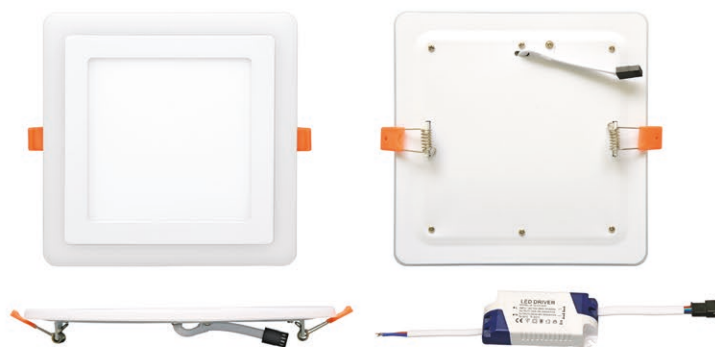





# LED / ZÁŘIVKOVÁ SVÍTLIDLA

## LED / ŽIARIVKOVÉ SVIETIDLÁ

**LED**

**LADA**  
**A+**

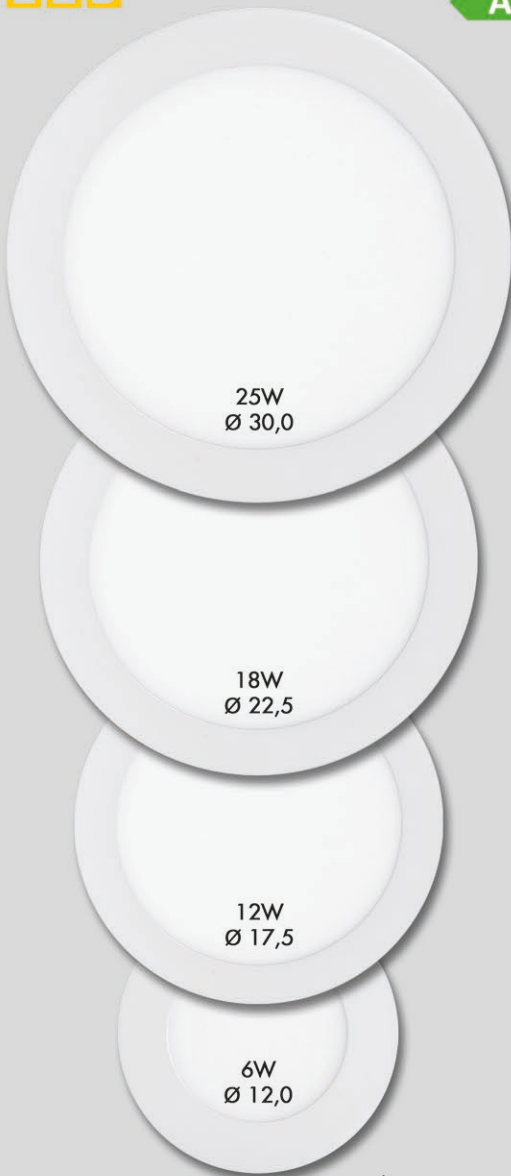

6W **420lm**



LED-WSL-6W/2700

12W **860lm**



LED-WSL-12W/2700

18W **1530lm**



LED-WSL-18W/2700

25W **2240lm**



LED-WSL-25W/2700

6W **440lm**



LED-WSL-6W/4100

12W **880lm**



LED-WSL-12W/4100

18W **1550lm**



LED-WSL-18W/4100

25W **2260lm**



LED-WSL-25W/4100

Ø 10,5

Ø 15,5

Ø 20,5

Ø 28,0

LED-WSL-6W/2700



LED-WSL-6W/4100



LED-WSL-12W/2700



LED-WSL-12W/4100



LED-WSL-18W/2700



LED-WSL-18W/4100



LED-WSL-25W/2700



LED-WSL-25W/4100



TL390X-LED-EM



modul pro nouzové osvětlení  
detail na str. 42





# LED / ZÁŘIVKOVÁ SVÍTIDLA

## LED / ŽIARIVKOVÉ SVIETIDLÁ

**LED**

**RAFA**

**A+**

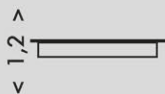

6W <b>420lm</b>	6W <b>440lm</b>	10,5x10,5	LED-WSQ-6W/2700	85908491513127
LED-WSQ-6W/2700	LED-WSQ-6W/4100		LED-WSQ-6W/4100	85908491513141
12W <b>860lm</b>	12W <b>880lm</b>	15,5x15,5	LED-WSQ-12W/2700	85908491513165
LED-WSQ-12W/2700	LED-WSQ-12W/4100		LED-WSQ-12W/4100	85908491513189
18W <b>1530lm</b>	18W <b>1550lm</b>	20,5x20,5	LED-WSQ-18W/2700	85908491513202
LED-WSQ-18W/2700	LED-WSQ-18W/4100		LED-WSQ-18W/4100	85908491513226
25W <b>2240lm</b>	25W <b>2260lm</b>	28,0x28,0	LED-WSQ-25W/2700	85908491513240
LED-WSQ-25W/2700	LED-WSQ-25W/4100		LED-WSQ-25W/4100	85908491513264



TL390X-LED-EM  
modul pro nouzové osvětlení  
detail na str. 42

- CE
- ~230V
- F
- SMD chip
- max. 6W
- max. 12W
- max. 18W
- max. 25W
- 140°
- IP44
- 30000h
- 2700K
- 4100K
- Ra ≥80
- House icon
- LED chip icon
- A+ icon





# LED / ZÁŘIVKOVÁ SVÍTLIDLA

## LED / ŽIARIVKOVÉ SVIETIDLÁ

**LED**

**LADA**  
A+



6W <b>420lm</b>	6W <b>440lm</b>	Ø 10,5	LED-WSL-6W/27/CHR 8 590 849 15 244 82
LED-WSL-6W/27/CHR	LED-WSL-6W/41/CHR		LED-WSL-6W/41/CHR 8 590 849 15 245 05
12W <b>860lm</b>	12W <b>880lm</b>	Ø 15,5	LED-WSL-12W/27/CHR 8 590 849 15 243 69
LED-WSL-12W/27/CHR	LED-WSL-12W/41/CHR		LED-WSL-12W/41/CHR 8 590 849 15 243 83
18W <b>1530lm</b>	18W <b>1550lm</b>	Ø 20,5	LED-WSL-18W/27/CHR 8 590 849 15 244 06
LED-WSL-18W/27/CHR	LED-WSL-18W/41/CHR		LED-WSL-18W/41/CHR 8 590 849 15 244 20
25W <b>2240lm</b>	25W <b>2260lm</b>	Ø 28,0	LED-WSL-25W/27/CHR 8 590 849 15 244 44
LED-WSL-25W/27/CHR	LED-WSL-25W/41/CHR		LED-WSL-25W/41/CHR 8 590 849 15 244 68

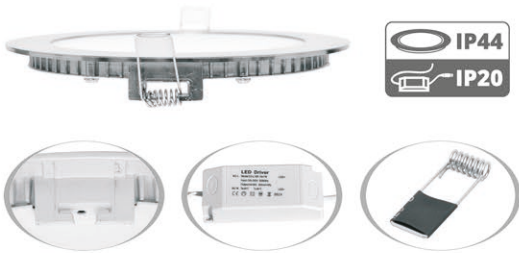

**TL390X-LED-EM**  
modul pro nouzové osvětlení  
detail na str. 42

- CE
- ~230V
- F
- SMD chip
- max. 6W
- max. 12W
- max. 18W
- max. 25W
- 140°
- IP44
- 30000h
- 2700K
- 4100K
- Ra ≥80
- House icon
- Chip icon
- A+ icon







# LED / ZÁŘIVKOVÁ SVÍTIDLA

## LED / ŽIARIVKOVÉ SVIETIDLÁ

**LED**

**RAFA**

**A+**

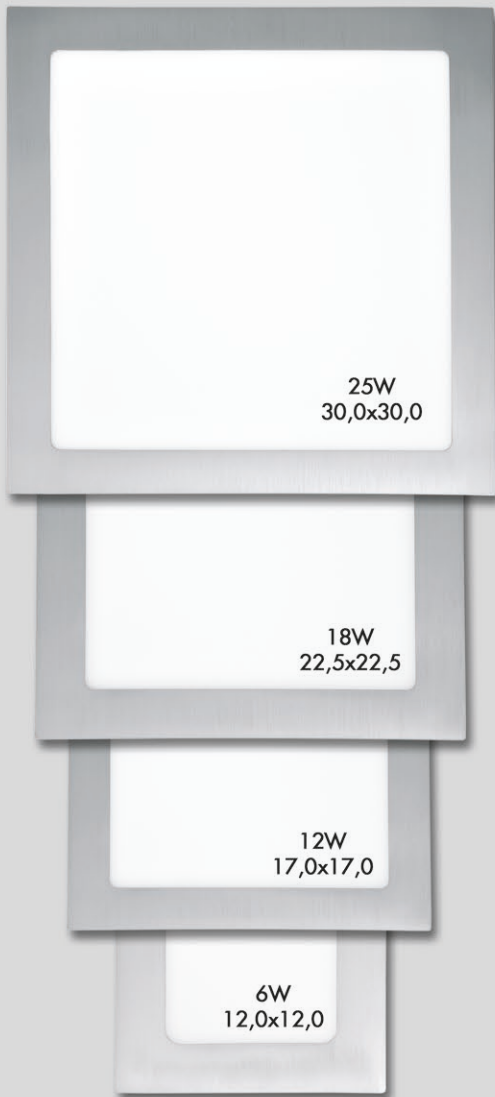

25W  
30,0x30,0

18W  
22,5x22,5

12W  
17,0x17,0

6W  
12,0x12,0

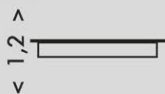

6W <b>420lm</b>	6W <b>440lm</b>	10,5x10,5	LED-WSQ-6W/27/CHR 8 590 849 15 246 42
LED-WSQ-6W/27/CHR	LED-WSQ-6W/41/CHR		LED-WSQ-6W/41/CHR 8 590 849 15 246 66
12W <b>860lm</b>	12W <b>880lm</b>	15,5x15,5	LED-WSQ-12W/27/CHR 8 590 849 15 245 29
LED-WSQ-12W/27/CHR	LED-WSQ-12W/41/CHR		LED-WSQ-12W/41/CHR 8 590 849 15 245 43
18W <b>1530lm</b>	18W <b>1550lm</b>	20,5x20,5	LED-WSQ-18W/27/CHR 8 590 849 15 245 67
LED-WSQ-18W/27/CHR	LED-WSQ-18W/41/CHR		LED-WSQ-18W/41/CHR 8 590 849 15 245 81
25W <b>2240lm</b>	25W <b>2260lm</b>	28,0x28,0	LED-WSQ-25W/27/CHR 8 590 849 15 246 04
LED-WSQ-25W/27/CHR	LED-WSQ-25W/41/CHR		LED-WSQ-25W/41/CHR 8 590 849 15 246 28

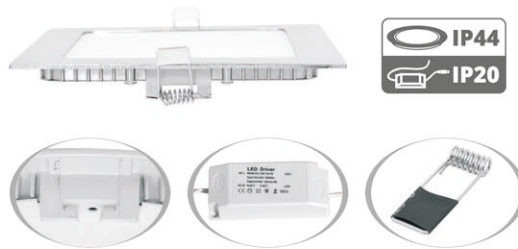

**IP44**  
**IP20**

**TL390X-LED-EM**

modul pro nouzové osvětlení  
detail na str. 42





# LED / ZÁŘIVKOVÁ SVÍTIDLA

## LED / ŽIARIVKOVÉ SVIETIDLÁ

**LED**

**LADA 2**

**A+**



12W **860lm**



LED-CSL-12W/2700

12W **880lm**



LED-CSL-12W/4100

18W **1530lm**



LED-CSL-18W/2700

18W **1550lm**



LED-CSL-18W/4100

25W **2240lm**



LED-CSL-25W/2700

25W **2260lm**



LED-CSL-25W/4100

LED-CSL-12W/2700



LED-CSL-12W/4100



LED-CSL-18W/2700



LED-CSL-18W/4100



LED-CSL-25W/2700



LED-CSL-25W/4100



TL390X-LED-EM



modul pro nouzové osvětlení  
detail na str. 42





# LED / ZÁŘIVKOVÁ SVÍTIDLA

## LED / ŽIARIVKOVÉ SVIETIDLÁ

**LED**

**RAFA 2**

**A+**



25W  
30,0x30,0



18W  
22,5x22,5



12W  
17,0x17,0



12W **860lm**



LED-CSQ-12W/2700

12W **880lm**



LED-CSQ-12W/4100

18W **1530lm**



LED-CSQ-18W/2700

18W **1550lm**



LED-CSQ-18W/4100

25W **2240lm**



LED-CSQ-25W/2700

25W **2260lm**



LED-CSQ-25W/4100

LED-CSQ-12W/2700



LED-CSQ-12W/4100



LED-CSQ-18W/2700



LED-CSQ-18W/4100



LED-CSQ-25W/2700



LED-CSQ-25W/4100

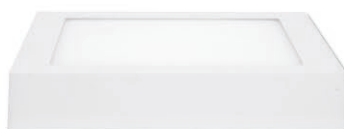

TL390X-LED-EM



modul pro nouzové osvětlení  
detail na str. 42







# LED / ZÁŘIVKOVÁ SVÍTLIDLA

## LED / ŽIARIVKOVÉ SVIETIDLÁ

**LED**

**LADA 2**  
A+

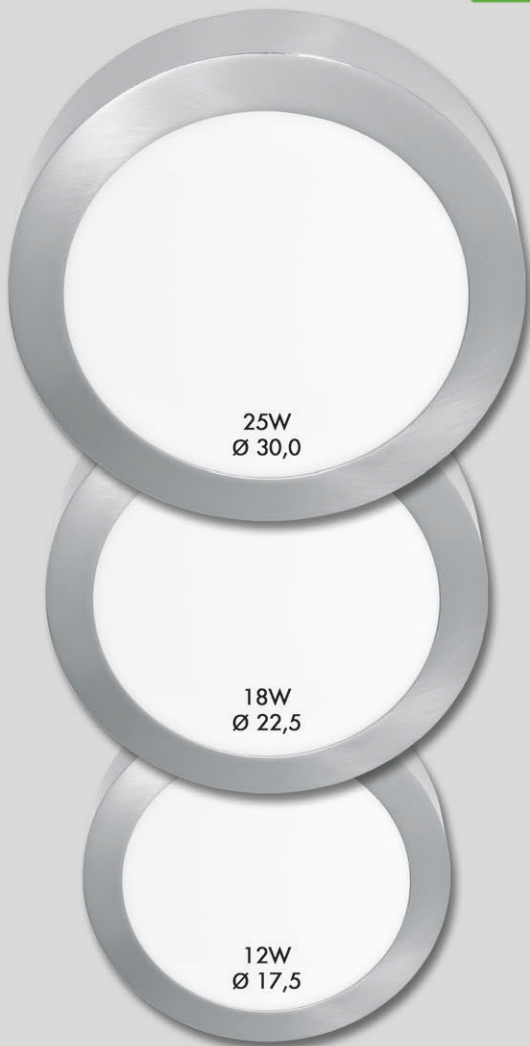

25W  
Ø 30,0

18W  
Ø 22,5

12W  
Ø 17,5



12W **860lm**



LED-CSL-12W/27/CHR

12W **880lm**



LED-CSL-12W/41/CHR

18W **1530lm**



LED-CSL-18W/27/CHR

18W **1550lm**



LED-CSL-18W/41/CHR

25W **2240lm**



LED-CSL-25W/27/CHR

25W **2260lm**



LED-CSL-25W/41/CHR

LED-CSL-12W/27/CHR



LED-CSL-12W/41/CHR



LED-CSL-18W/27/CHR



LED-CSL-18W/41/CHR



LED-CSL-25W/27/CHR



LED-CSL-25W/41/CHR



TL390X-LED-EM



modul pro nouzové osvětlení  
detail na str. 42





# LED / ZÁŘIVKOVÁ SVÍTIDLA

## LED / ŽIARIVKOVÉ SVIETIDLÁ

**LED**

**RAFA 2**

**A+**



12W <b>860lm</b>	12W <b>880lm</b>
LED-CSQ-12W/2700/CHR	LED-CSQ-12W/4100/CHR
18W <b>1530lm</b>	18W <b>1550lm</b>
LED-CSQ-18W/2700/CHR	LED-CSQ-18W/4100/CHR
25W <b>2240lm</b>	25W <b>2260lm</b>
LED-CSQ-25W/2700/CHR	LED-CSQ-25W/4100/CHR

LED-CSQ-12W/27/CHR



LED-CSQ-12W/41/CHR



LED-CSQ-18W/27/CHR



LED-CSQ-18W/41/CHR



LED-CSQ-25W/27/CHR



LED-CSQ-25W/41/CHR



TL390X-LED-EM



modul pro nouzové osvětlení  
detail na str. 42





# LED / ZÁŘIVKOVÁ SVÍTLIDLA

## LED / ŽIARIVKOVÉ SVIETIDLÁ

**PROFIL**



DX-AP05-PROFIL

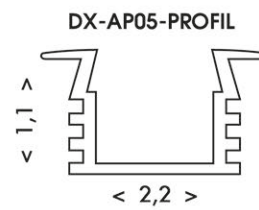

DX-AP05-PROFIL



DX-AP06-PROFIL



DX-AP06-PROFIL



DX-AP07-PROFIL



DX-AP07-PROFIL



DX-KRYT/CIR



DX-KRYT/ML



DX-AP05-END



DX-AP06/07-END



DX-KLIP



DX-KRYT/CIR



DX-KRYT/ML



DX-AP05-END



DX-AP06/07-END



DX-KLIP





NOVINKA  
LED

SMD STRIP  
A+



25m 1200lm/m



DX-60SMD-2700/25M

25m 1200lm/m



DX-60SMD-4100/25M

25m 1200lm/m



DX-60SMD-6000/25M

DX-60SMD-2700/25M



DX-60SMD-4100/25M



DX-60SMD-6000/25M

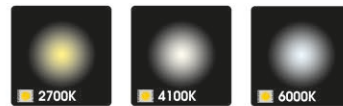

NOVINKA  
LED

SMD STRIP  
A+



25m 2400lm/m



DX-120SMD-2700/25M

25m 2400lm/m



DX-120SMD-4100/25M

25m 2400lm/m



DX-120SMD-6000/25M

DX-120SMD-2700/25M



DX-120SMD-4100/25M



DX-120SMD-6000/25M

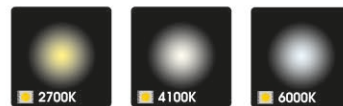

NOVINKA

SMD SPOJ

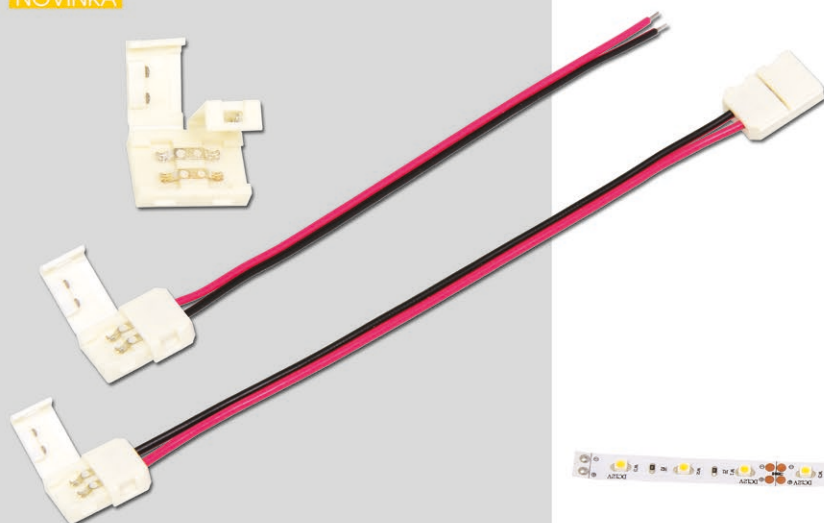

DX-SPOJ-1

DX-SPOJ-1B

DX-SPOJ-2

DX-SPOJ-1



DX-SPOJ-1B



DX-SPOJ-2





**DX-WP-18W/IP67**



**DX-WP-100W/IP67**



**DX-WP-30W/IP67**



**DX-WP-150W/IP67**



**DX-WP-60W/IP67**



**DX-WP-200W/IP67**

**DX-WP-18W/IP67**



8 590 849 1510041

**DX-WP-30W/IP67**



8 590 849 1508901

**DX-WP-60W/IP67**



8 590 849 1508918

**DX-WP-100W/IP67**



8 590 849 1510010

**DX-WP-150W/IP67**



8 590 849 1510034

**DX-WP-200W/IP67**



8 590 849 1508895

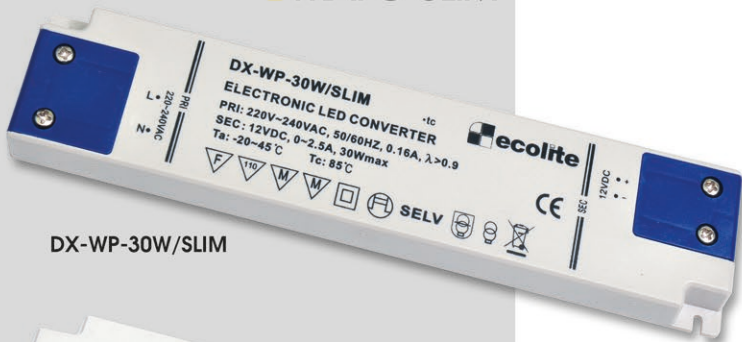

**DX-WP-30W/SLIM**

**DX-WP-30W/SLIM**



8 590 849 1512113

**DX-WP-50W/SLIM**



8 590 849 1519945



**DX-WP-50W/SLIM**



LED

SMD TV

A+



DX-LEDTV-RGB

DX-LEDTV-RGB



2 x < 60,0 >



LED

STRIP SET



1,5m 300lm/m



DX-SMD3528-BI/1,5M

5m 300lm/m



DX-SMD3528-BI/5M

DX-SMD3528-BI/1,5M



DX-SMD3528-BI/5M



LED

STRIP SET RGB



1,5m max. 800lm/m



DX-SMD5050-RGB/1,5M

5m max. 800lm/m



DX-SMD5050-RGB/5M

DX-SMD5050-RGB/1,5M



DX-SMD5050-RGB/5M





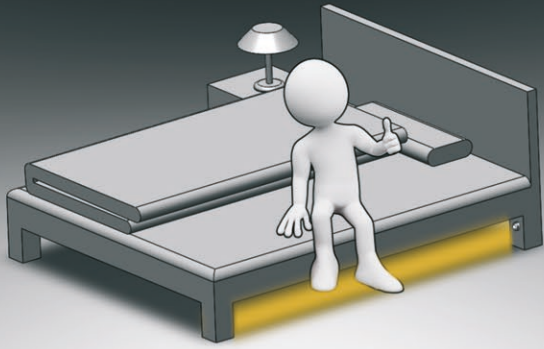

# LED / ZÁŘIVKOVÁ SVÍTIDLA

## LED / ŽIARIVKOVÉ SVIETIDLÁ

**LED**

**STRIP**  
**A+**



200lm/m



DX-CDA-1

DX-CDA-1



**LED**

**STRIP**  
**A+**



200lm/m



DX-CDA-2

DX-CDA-2





NOVINKA  
**LED**



10W **850lm**

20W **1700lm**

TL4009-LED10W

TL4009-LED20W



15W **1300lm**

24W **2200lm**

TL4009-LED15W

TL4009-LED24W



< 2,9 >  
4,4 >  
< 4,4 >  
10W < 60,0 >  
15W < 90,0 >  
20W < 120,0 >  
24W < 150,0 >

Ecolite TL4009-SMD

Toto svítidlo obsahuje světelné zdroje LED.

A+  
A  
A  
C  
D  
E

LED

Světelné zdroje LED v tomto svítidle nelze vyměnit.

874/2012

CE	~230V	F	SMD chip	⏚
max. 10W	max. 15W	max. 20W	max. 24W	150°
IP20	30000h	4100K	Ra ≥80	🏠
AI	📦	20	20W=12	24W=12



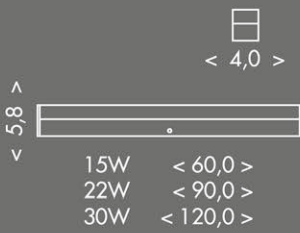

NOVINKA  
**LED**



15W **1200lm**

TL4130-15W/BI



8 59 08 49 52 92 65

22W **1760lm**

TL4130-22W/BI



8 59 08 49 52 92 72

30W **2400lm**

TL4130-30W/BI



8 59 08 49 52 92 89

Ecolite TL4130

Toto svítidlo obsahuje světelné zdroje LED.

**A+**  
**A+**  
**A**  
**C**  
**D**  
**F**

**LED**

Světelné zdroje LED v tomto svítidle nelze vyměnit.

874/2012

CE	~230V	F	SMD chip	⏚
max. 15W	max. 22W	max. 30W	IP44	🏠
30000h	4000K	Ra ≥80	🔌	📦
📦	12			





NOVINKA  
LED

ALBA  
A+

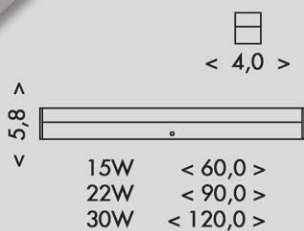

15W 1200lm

TL4130-15W/STR

22W 1760lm

TL4130-22W/STR

30W 2400lm

TL4130-30W/STR

TL4130-15W/STR



8 590849 529296

TL4130-22W/STR



8 590849 529302

TL4130-30W/STR



8 590849 529319



NOVINKA  
LED

ALBA  
A+

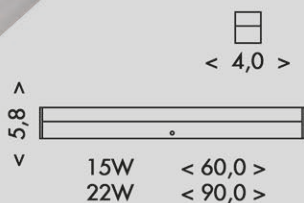

15W 1200lm

TL4130-15W/CHR

22W 1760lm

TL4130-22W/CHR

TL4130-15W/CHR



8 590849 529326

TL4130-22W/CHR



8 590849 529333





**LED**



5,5W **440lm**



TL2016-28SMD/5,5W



8 590849 519136

10W **800lm**



TL2016-42SMD/10W



8 590849 519143

15W **1200lm**



TL2016-70SMD/15W



8 590849 519150

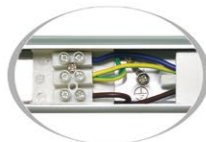
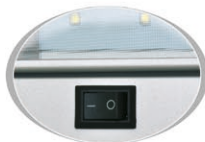

< 8,4 >  
  
 < 2,8 >  
 5,5W < 35,5 >  
 10W < 58,4 >  
 15W < 91,7 >

Ecolite TL2016-SMD

Toto svítidlo obsahuje světelné zdroje LED.

**A+**  
**A+**  
**A**  
**C**  
**D**  
**F**

**LED**

Světelné zdroje LED v tomto svítidle nelze vyměnit.

874/2012

	~230V		SMD chip	
max. 5,5W	max. 10W	max. 15W	IP20	30000h
4100K	Ra ≥80			
12	3			



## LED



5,5W **440lm**



TL2016-28SMD/5,5W/BI



8 590849 521696

10W **800lm**



TL2016-42SMD/10W/BI



8 590849 521726

15W **1200lm**



TL2016-70SMD/15W/BI



8 590849 521757



Ecolite TL2016-SMD

Toto svítidlo obsahuje světelné zdroje LED.

A+ A A C D F

LED

Světelné zdroje LED v tomto svítidle nelze vyměnit.

874/2012

CE	~230V	F	SMD chip	⏚
max. 5,5W	max. 10W	max. 15W	IP20	30000h
4100K	Ra ≥80	🏠	🔌	✈️
📦 12	📦 3			

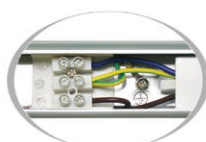





## LED



5W **450lm**



TL2001-28SMD/5W



8 590849 519792

8W **780lm**



TL2001-56SMD/8W



8 590849 519808

12W **1070lm**



TL2001-70SMD/12W



8 590849 519815

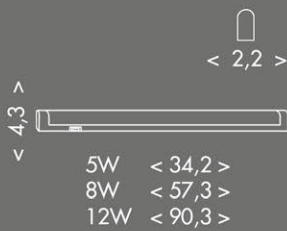

Ecolite TL2001-SMD

Toto svítidlo obsahuje světelné zdroje LED.

A+ A A C D F

LED

Světelné zdroje LED v tomto svítidle nelze vyměnit.

874/2012

CE	~230V	F	SMD chip	
max. 5W	max. 8W	max. 12W	IP20	
30000h	4100K	Ra ≥80		
20	12W=10	10	12W=5	





## LED / ZÁŘIVKOVÁ SVÍTIDLA

### LED / ŽIARIVKOVÉ SVIETIDLÁ

**SLICK**

**A**

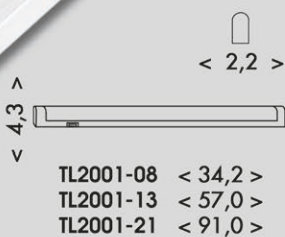

TL2001-08



TL2001-13



TL2001-21



TL2001-08



8 590849 420108 6

TL2001-13



8 590849 420113 0

TL2001-21



8 590849 420121 5



**SLICK**

**A**

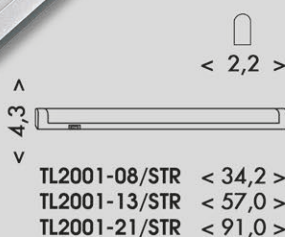

TL2001-08/STR



TL2001-13/STR



TL2001-21/STR

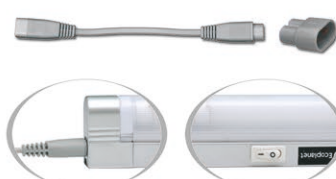

TL2001-08/STR



8 590849 449862 2

TL2001-13/STR



8 590849 449865 3

TL2001-21/STR



8 590849 449868 4







# LED / ZÁŘIVKOVÁ SVÍTLIDLA

## LED / ŽIARIVKOVÉ SVIETIDLÁ

**GANYS**

**A**

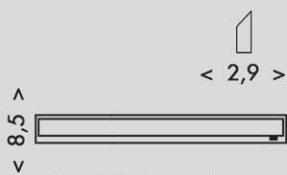

TL2016-08 < 35,5 >  
 TL2016-13 < 58,4 >  
 TL2016-21 < 91,7 >



TL2016-08



TL2016-13



TL2016-21



TL2016-08



TL2016-13



TL2016-21



**GANYS**

**A**



TL2016-08/BI < 35,5 >  
 TL2016-13/BI < 58,4 >  
 TL2016-21/BI < 91,7 >



TL2016-08/BI



TL2016-13/BI



TL2016-21/BI



TL2016-08/BI



TL2016-13/BI



TL2016-21/BI







# LED / ZÁŘIVKOVÁ SVÍTIDLA

## LED / ŽIARIVKOVÉ SVIETIDLÁ

**DINO**

**A**

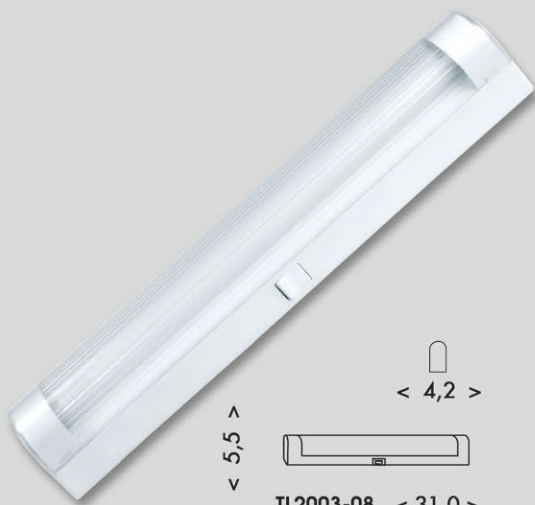

< 5,5 >  
 < 4,2 >  
 TL2003-08 < 31,0 >  
 TL2003-13 < 54,0 >



TL2003-08



TL2003-13



TL2003-08



TL2003-13



**CAPRI**

**A**

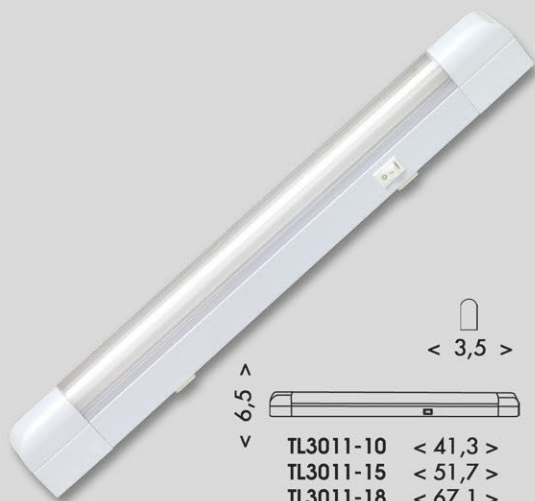

< 6,5 >  
 < 3,5 >  
 TL3011-10 < 41,3 >  
 TL3011-15 < 51,7 >  
 TL3011-18 < 67,1 >  
 TL3011-36 < 128,0 >



TL3011-10



TL3011-15



TL3011-18



TL3011-36



TL3011-10



TL3011-15



TL3011-18



TL3011-36



## KORADO

A



10,3 >	< 4,2 >
< 38,0 >	
< 48,5 >	
< 64,2 >	
< 125,0 >	



TL3013-10



TL3013-15



TL3013-18



TL3013-36



TL3013-10



8 590849 313109

TL3013-15



8 590849 313154

TL3013-18



8 590849 313185

TL3013-36



8 590849 313208



## DERIK

A

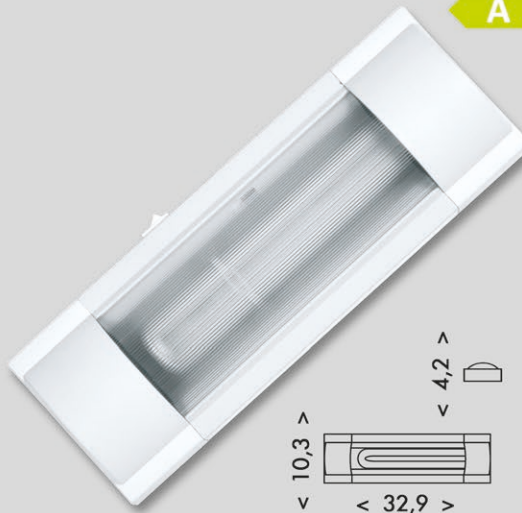

10,3 >	< 4,2 >
< 32,9 >	



TL3014-11



TL3014-11



8 590849 034110



## ROSA

A



8,2 >	< 6,2 >
< 49,5 >	
< 60,0 >	
< 75,5 >	



TL3020-10



TL3020-15



TL3020-18



TL3020-10



8 590849 302103

TL3020-15



8 590849 302158

TL3020-18



8 590849 302189



# MONTÁŽNÍ LAMPY

---

## MONTÁŽNE LAMPY





LED

MONTER

A+



LED809-60/AKU

LED809-60/AKU



LED

MECHANIC

A+

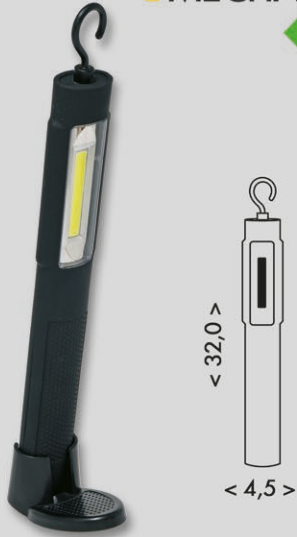

XD46B-3W/AKU

XD46B-3W/AKU



WORKER

A - D



TL2024-60

TL2024-60



**TECHNICKÁ SVÍTIDLA**  
TECHNICKÉ SVIETIDLÁ





   
 < 8,5 >   
 < 7,5 >   
 TLSE4T-LED40W < 120,0 >   
 TLSE5T-LED60W < 150,0 >

Ecolite TLSE4T-LED

Toto svítidlo obsahuje světelné zdroje LED.

**A++** CLASS SMD CHIPSET

**LIFUD DRIVER**

Světelné zdroje LED v tomto svítidle nelze vyměnit.

874/2012

CE	~230V	F	SMD chip	max. 40W
max. 60W	⏚	IP65	IK10	30000h
4100K	Ra ≥80	🏠	⚡	PC
📦	6			

NOVINKA  
**LED**

**5 LET**  
GARANCE

**A++**  
CLASS  
SMD CHIPSET

**LIFUD**  
DRIVER



set 2ks



TLSE-ZAVES

> 200,0  
<







# TECHNICKÁ SVÍTLIDLA

## TECHNICKÉ SVIETIDLÁ

NOVINKA

LED

LIBRA SMD

A+



TL3901A-LED20W



TL3902A-LED40W



TL3903A-LED60W



20W **1800lm**



TL3901A-LED20W

40W **3600lm**



TL3902A-LED40W

60W **5100lm**



TL3903A-LED60W

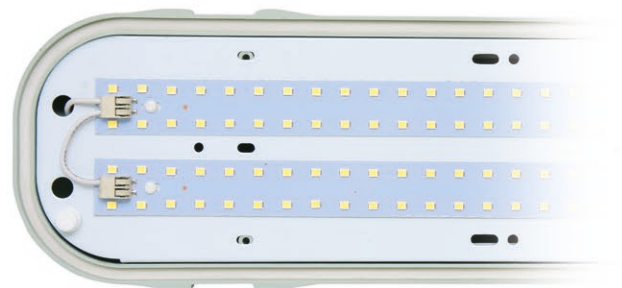

TL390X-LED-EM



modul pro nouzové osvětlení

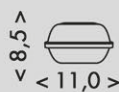

TL3901A-LED20W < 67,0 >  
 TL3902A-LED40W < 127,5 >  
 TL3903A-LED60W < 150,0 >



NOVINKA

LED

LIBRA SMD

A+

PHILIPS DRIVER

5 LET GARANCE

A+++ CLASS SMD CHIPSET



> 8,5 < 11,0



TL3902A-LED65W < 127,5 >  
TL3903A-LED80W < 150,0 >

TL3902A-LED65W



TL3903A-LED80W



65W 6000lm



TL3902A-LED65W

80W 7500lm



TL3903A-LED80W

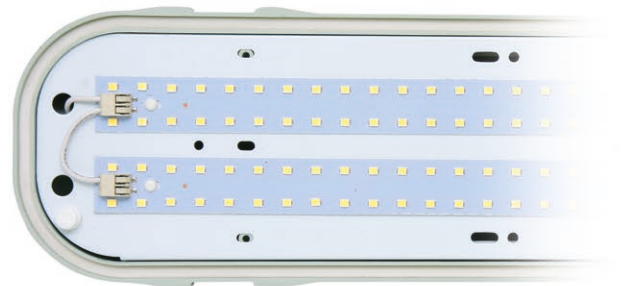

TL390X-LED-EM



modul pro nouzové osvětlení



NOVINKA

EMERGENCY

A+

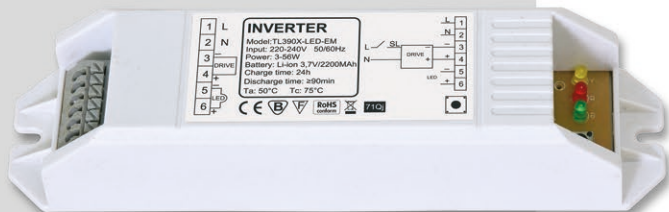

TL390X-LED-EM

TL390X-LED-EM

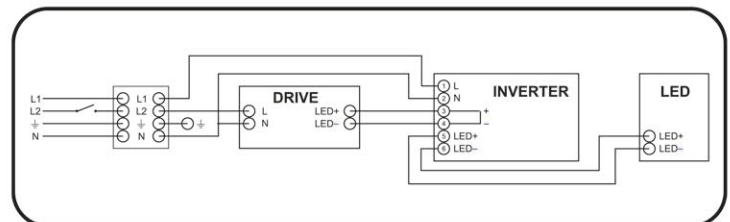



< 14,5 >  
 < 2,4 >  
 TL6022-LED25W < 54,0 >  
 TL6022-LED35W < 84,0 >  
 TL6022-LED48W < 114,0 >

**NOVINKA**  
**LED**



**25W 2500lm**

TL6022-LED25W



8 590849 528312

**35W 3700lm**

TL6022-LED35W



8 590849 528336

**48W 4900lm**

TL6022-LED48W



8 590849 528350

**Ecolite TL6022-LED**

Toto svítidlo obsahuje světelné zdroje LED.

**A+**  
**A**  
**A**  
**C**  
**D**  
**F**

**LED**

Světelné zdroje LED v tomto svítidle nelze vyměnit.

874/2012

	~230V		SMD chip	max. 25W
max. 35W	max. 48W	140°		IP20
30000h	4000K	Ra ≥80		
			6	







# TECHNICKÁ SVÍTLIDLA

## TECHNICKÉ SVIETIDLÁ

**LED**

PILO SMD

**A+**

TL220-LED18W



18W **1300lm**



TL220-LED18W



**LED**

PILO SMD

**A+**

TL240-LED36W



36W **2600lm**



TL240-LED36W





# TECHNICKÁ SVÍTLA

## TECHNICKÉ SVIETIDLÁ

PILO 2

A

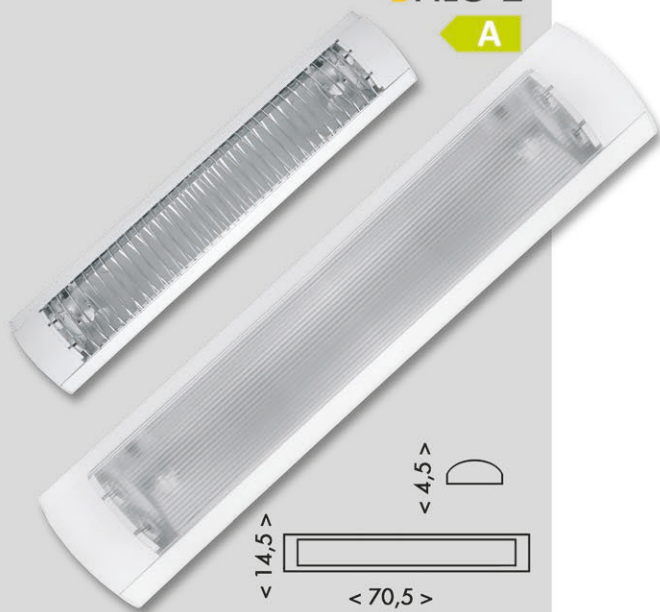

TL220MP-2x18/EVG



TL220MP-2x18/EVG



+



součástí balení



PILO 2

A



TL240MP-2x36/EVG



TL240MP-2x36/EVG

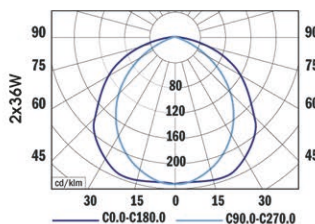
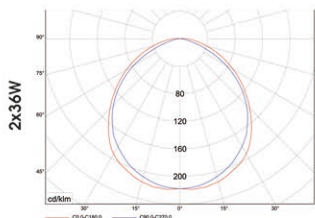

+



součástí balení





# TECHNICKÁ SVÍTLA

## TECHNICKÉ SVIETILÁ

**LIBRA**

**A**

TL3902A-2x36

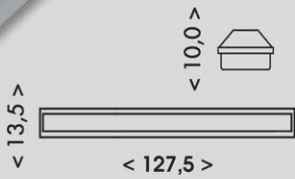

TL3902A-2x36

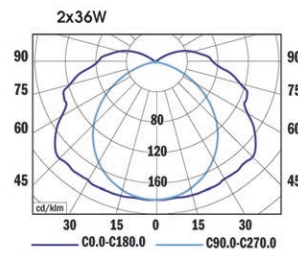

**LIBRA 2**

**A**

TL3902A-2x36/EVG

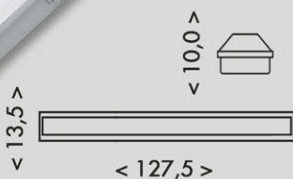

TL3902A-2x36/EVG

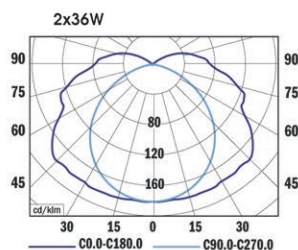





# TECHNICKÁ SVÍTLIDLA

## TECHNICKÉ SVIETIDLÁ

**LIBRA 2**

**A+**



TL3902A-2x36/B



TL3902A-2x36/B

**INSTALUJTE**  
LEDTUBE-120/20W



**LED**



**LED**

**LEDER 2**

**A+**

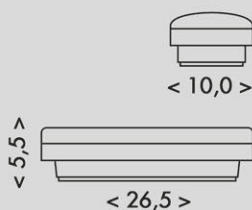

2,7W



TL507L-LED

TL507L-LED





# TECHNICKÁ SVÍTLA

## TECHNICKÉ SVIETIDLÁ

**LED**

**ALPHA**

**A+**

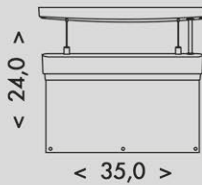

2W



TL939LM-LED/D

2W



TL939LM-LED/LP

TL939LM-LED/D



TL939LM-LED/LP

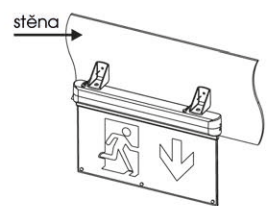
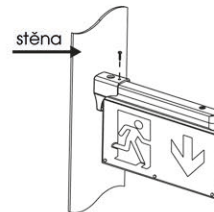
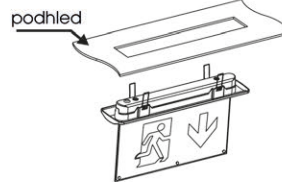

**ALPHA**



MATEXIT-TL939-D



MATEXIT-TL939-LP



MATEXIT-TL939-NH

MATEXIT-TL939-D



MATEXIT-TL939-LP



MATEXIT-TL939-NH





# TECHNICKÁ SVÍTLA

## TECHNICKÉ SVIETIDLÁ

**LED**

**LEDER**

**A+**



TL638L-LED

TL638L-LED

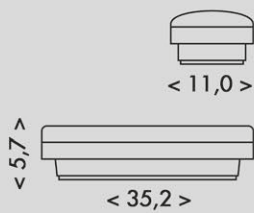

**EXIT**

**A**



TL106-06

TL106-06

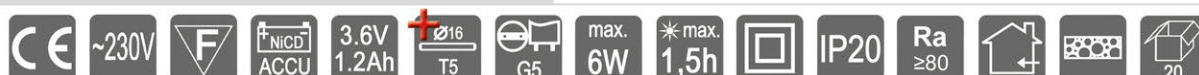
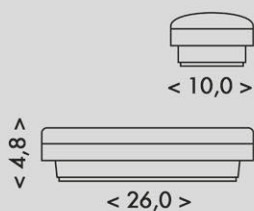





# TECHNICKÁ SVÍTLIDLA

## TECHNICKÉ SVIETIDLÁ

NOVINKA  
LED

LEDA  
A+

2,8W 150lm

TL8011LK-LED



TL8011LK-LED

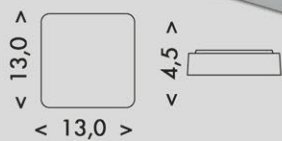
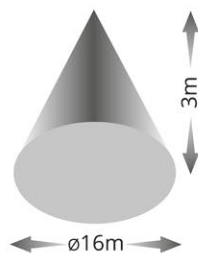

NOVINKA  
LED

LEDA  
A+

2,8W 150lm

TL8011LX-LED



TL8011LX-LED

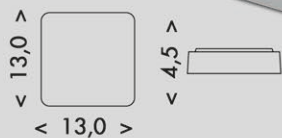
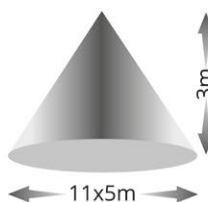



# TECHNICKÁ SVÍTIDLA

## TECHNICKÉ SVIETIDLÁ

**LED**

**LEDIS**  
**A+**

1,2W **120lm**



TL5205-30LED

TL5205-30LED



8 590 849 1502855

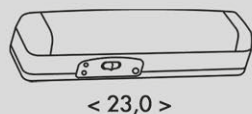
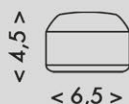



LED

OVAL

A+



12W < 4,0 >  
18W < 4,3 >



12W < 10,0 >  
18W < 10,5 >

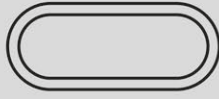

12W < 20,0 >  
18W < 23,0 >

12W 850lm



LED-BL12W-BI

18W 1300lm



LED-BL18W-BI

12W 850lm



LED-BL12W-SED

18W 1300lm



LED-BL18W-SED

LED-BL12W-BI



8 590 849 521638

LED-BL12W-SED



8 590 849 521627

LED-BL18W-BI



8 590 849 521597

LED-BL18W-SED



8 590 849 521566



LED

SMD MODUL

A+

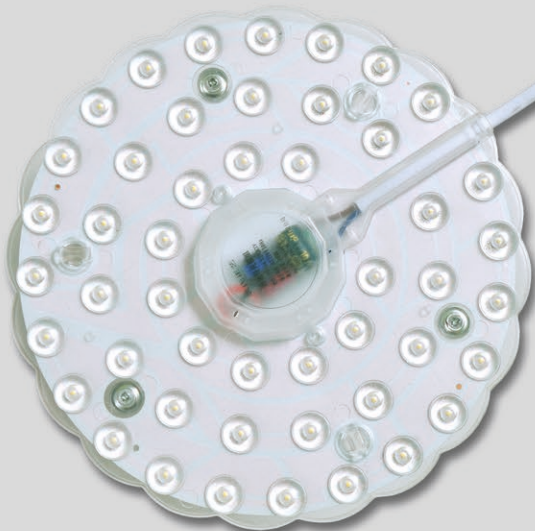

< 2,5 >

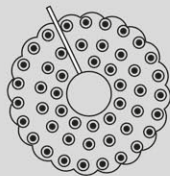

10W Ø 12,0  
16W Ø 18,0  
20W Ø 18,0  
24W Ø 19,0

10W 800lm

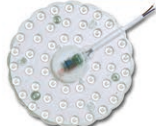

LED-MZ-10W/4100

20W 1800lm

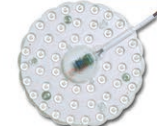

LED-MZ-20W/4100

16W 1440lm

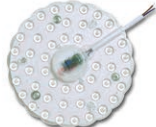

LED-MZ-16W/4100

24W 2160lm

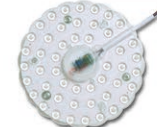

LED-MZ-24W/4100

16W 1420lm

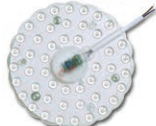

LED-MZ-16W/2700

24W 2140lm

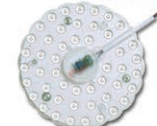

LED-MZ-24W/2700

20W 1780lm

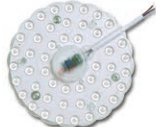

LED-MZ-20W/2700



LED-MZ-10W/4100



8 590 849 521917

LED-MZ-16W/4100



8 590 849 521924

LED-MZ-20W/4100



8 590 849 521931

LED-MZ-24W/4100



8 590 849 521948

LED-MZ-16W/2700



8 590 849 526240

LED-MZ-20W/2700



8 590 849 526264

LED-MZ-24W/2700



8 590 849 526288







# TECHNICKÁ SVÍTLA

## TECHNICKÉ SVIETILÁ

NEPTUN 2

A - D

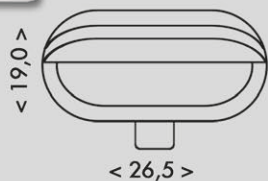

WHST69-BI



WHST69-CR

WHST69-BI



8 590849 1504750

WHST69-CR



8 590849 1505221

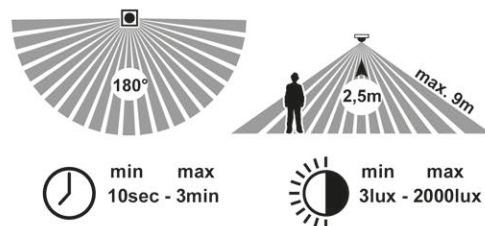

NEPTUN

A - D

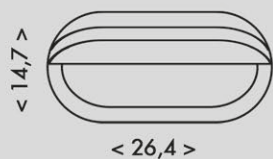

WH2606-BI



WH2606-CR

WH2606-BI



8 590849 1026061

WH2606-CR



8 590849 1026160



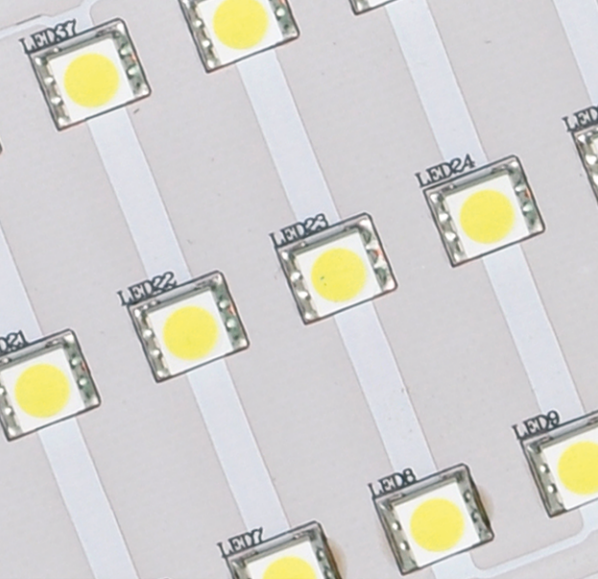

# TECHNICKÁ SVÍTLIDLA

## TECHNICKÉ SVIETIDLÁ

**LED**

**MODES**

**A+**

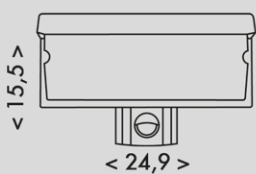

WHLX84-BI



WHLX84-CR



WHLX84-STR



WHLX84-BI



WHLX84-CR



WHLX84-STR

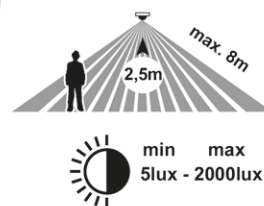
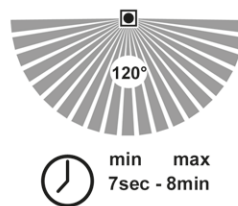

**FLAVIA**

**A - D**

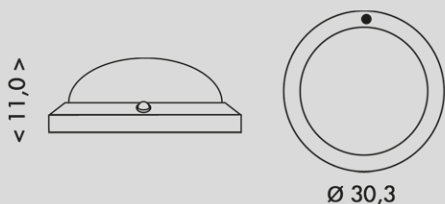

W121-BI



W121-STR

W121-BI



W121-STR

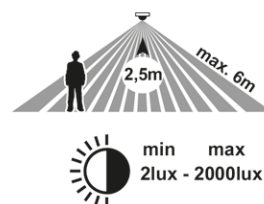
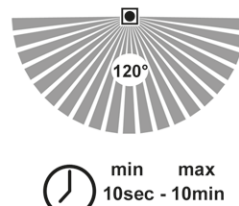

**LED****VICTOR LED****A+**

10,0

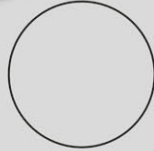

Ø 28,0

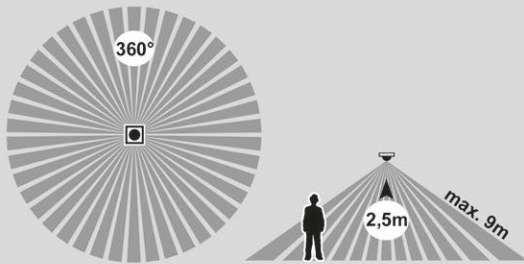

HF senzor detekuje pohyb i přes sklo a lehké stavební materiály.



1480lm



W131/EM/LED-3000

1480lm



W131/EM/LED-4100

W131/EM/LED-3000



8 590 849 45 25 724

W131/EM/LED-4100



8 590 849 45 25 748

**VICTOR LED B****LED****A+**

10,0

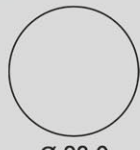

Ø 28,0

V případě propojování s dalšími svítidly je možné zapojení výhradně s modely W131/EM/LED/B - (maximálně 5ksů) v opačném případě nezaručujeme správnou funkčnost.

1480lm



W131/EM/LED/B-3000

1480lm



W131/EM/LED/B-4100

W131/EM/LED/B-3000



8 590 849 45 25 762

W131/EM/LED/B-4100



8 590 849 45 25 786





**LED****VICTOR LED****A+**

> 10,0  
<

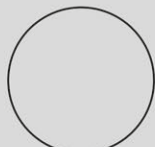

Ø 28,0

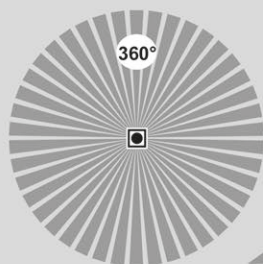

360°



2,5m

max. 9m

HF senzor detekuje pohyb i přes sklo a lehké stavební materiály.



min 8sec - 12min



min 2lux - 2000lux



W131/LED

Σ max. 1200W

**1480lm**

W131/LED-3000

**1480lm**

W131/LED-4100

W131/LED-3000



8 590 849 15 145 82

W131/LED-4100



8 590 849 15 145 99

**LED****VICTOR LED B****A+**

> 10,0  
<

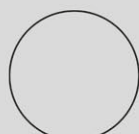

Ø 28,0

**1480lm**

W131/LED/B-3000

**1480lm**

W131/LED/B-4100

W131/LED/B-3000



8 590 849 15 146 05

W131/LED/B-4100



8 590 849 15 146 12





# TECHNICKÁ SVÍTLA

## TECHNICKÉ SVIETIDLÁ

VICTOR

A - D



> 10,0 <



Ø 27,5



W131-BI

Σ max. 1200W



W131-BI

W131-BI



85908491501414

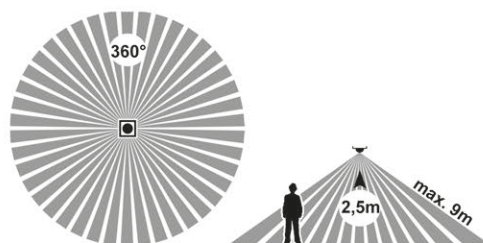

HF senzor detekuje pohyb i přes sklo a lehké stavební materiály.

min max  
8sec - 12min

min max  
2lux - 2000lux



VICTOR B

A - D



> 10,0 <

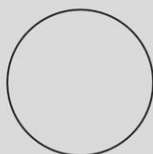

Ø 27,5



W131/B-BI

W131/B-BI



85908491502091



**VICTOR**  
**A - D**



W141-BI

W141-BI



< 12,0 >

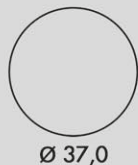

Ø 37,0

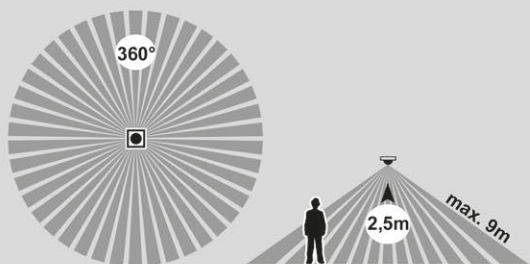

HF senzor detekuje pohyb i přes sklo a lehké stavební materiály.

min 8sec - max 12min

min 2lux - max 2000lux



W141-BI

Σ max. 1200W



**VICTOR B**  
**A - D**



W141/B-BI

W141/B-BI



< 12,0 >

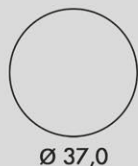

Ø 37,0





**LED****VICTOR LED****A+**

&lt; 12,0 &gt;

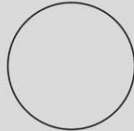

Ø 37,0

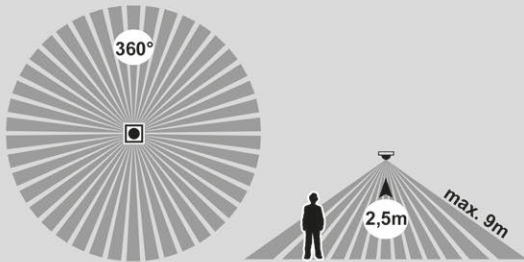

HF senzor detekuje pohyb i přes sklo a lehké stavební materiály.

min 8sec - max 12min

min 2lux - max 2000lux



W141/LED

Σ max. 1200W

**1900lm**

W141/LED-3000

**1900lm**

W141/LED-4100

W141/LED-3000



8 590 849 45 180 85

W141/LED-4100



8 590 849 45 180 78

**LED****VICTOR LED B****A+**

&lt; 12,0 &gt;

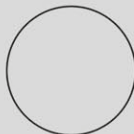

Ø 37,0

**1900lm**

W141/LED/B-3000

**1900lm**

W141/LED/B-4100

W141/LED/B-3000



8 590 849 45 180 61

W141/LED/B-4100



8 590 849 45 180 54





# TECHNICKÁ SVÍTLA

## TECHNICKÉ SVIETIDLÁ

VERA

A - D

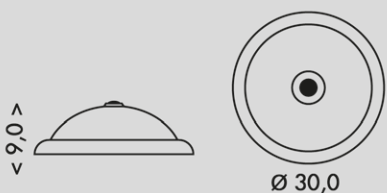

WHST78-BI

WHST78-BI

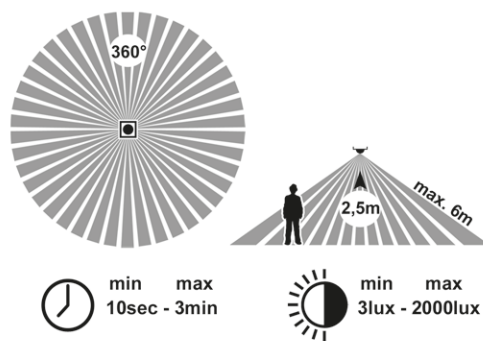

VERA SMD

LED

A+

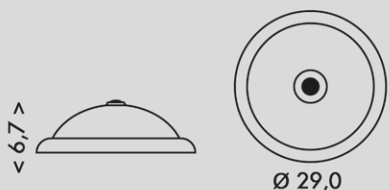

WHST78/LED-3000

WHST78/LED-3000



WHST78/LED-4100

WHST78/LED-4100

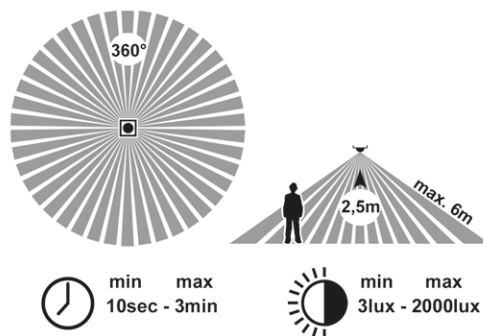

LORA

NOVINKA

LED

A+



15W 1300lm



WHST71-LED

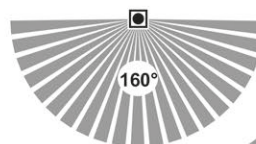

min max  
10sec - 12min

min max  
3lux - 2000lux

WHST71-LED



MOVA

NOVINKA

LED

A+



16W 1500lm



WHST707-LED

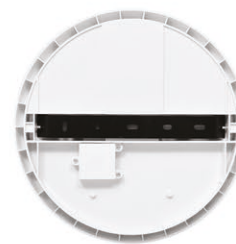

WHST707-LED



MOVA 2

NOVINKA

LED

A+



16W 1500lm



WHST707-LED/HF

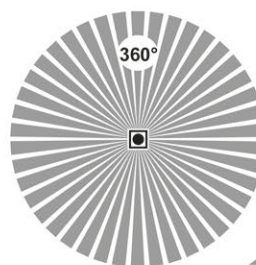

HF senzor detekuje pohyb i přes sklo a lehké stavební materiály.

min max  
10sec - 12min

min max  
3lux - 2000lux

WHST707-LED/HF





NOVINKA  
LED

NELA  
A+

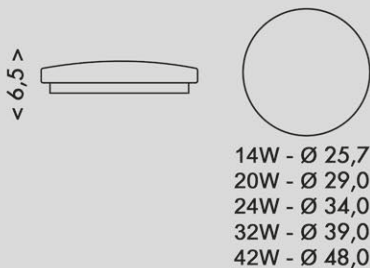

14W 980lm



WCL19R-14W/LED

20W 1400lm



WCL19R-20W/LED

24W 1800lm



WCL19R-24W/LED

32W 2700lm



WCL19R-32W/LED

42W 3300lm



WCL19R-42W/LED



WCL19R-14W/LED



WCL19R-20W/LED



WCL19R-24W/LED



WCL19R-32W/LED



WCL19R-42W/LED



NOVINKA  
LED

NELA 2  
A+

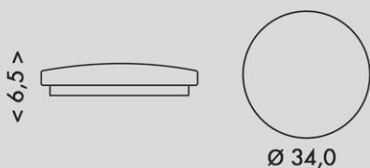

24W 1800lm



WCL19R-HF/24W/LED

WCL19R-HF/24W/LED



ON DP		Detekční zóna	Doba svícení		Nastavení světla
1	2	1	2	3	4
ON	DP	100% ON	5s ON	ON	25Lux ON
1	2	50% —	1min ON	—	vypnuto —
			3min —	ON	
			5min —	—	

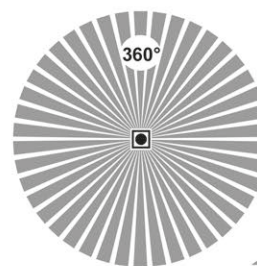



# TECHNICKÁ SVÍTIDLA

## TECHNICKÉ SVIETIDLÁ

NOVINKA  
LED

LUKA  
A+



20W - 28,0x28,0  
32W - 33,0x33,0  
42W - 43,0x43,0



20W - 6,0  
32W - 6,5  
42W - 7,8

20W **1500lm**



WCL19S-20W/LED

32W **2700lm**



WCL19S-32W/LED

42W **3300lm**



WCL19S-42W/LED

WCL19S-20W/LED



WCL19S-32W/LED



WCL19S-42W/LED





# BYTOVÁ SVÍTIDLA

## BYTOVÉ SVIETIDLÁ

NOVINKA  
LED

MODERNA  
A+

210W 9980lm

WALP02-210W/LED



WALP02-210W/LED

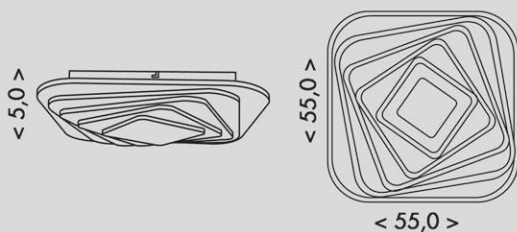



NOVINKA  
LED

VELA  
A+



60W 3960lm



WALP03-60W/LED

WALP03-60W/LED

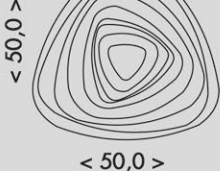
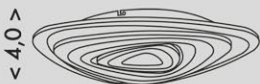

NOVINKA  
LED

ART  
A+



130W 8250lm



WALP04-130W/LED

WALP04-130W/LED

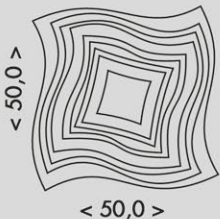

NOVINKA  
LED

DRAGO  
A+



80W 5480lm



WALP05-80W/LED

WALP05-80W/LED

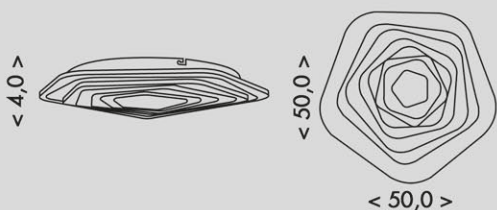

NOVINKA  
LED

ORION  
A+



60W 3960lm



WALP08-60W/LED

WALP08-60W/LED

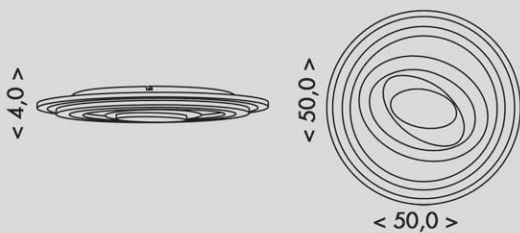





# BYTOVÁ SVÍTLA

## BYTOVÉ SVIETIDLÁ

NOVINKA

LED

LENA

A+

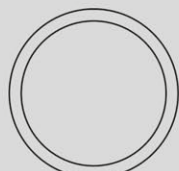

Ø - 24W 42,0  
Ø - 60W 52,0  
Ø - 80W 62,0



24W 9,0  
60W 9,0  
80W 10,0

24W 1600lm



WLD400-24W/LED/SD

60W 4000lm



WLD500-60W/LED/SD

80W 5200lm



WLD600-80W/LED/SD

24W 1600lm



WLD400-24W/LED/TD

60W 4000lm



WLD500-60W/LED/TD



STAR efekt

WLD400-24W/LED/SD



WLD400-24W/LED/TD



WLD500-60W/LED/SD



WLD500-60W/LED/TD



WLD600-80W/LED/SD





NOVINKA  
LED

ARION  
A+

10W 850lm



WALR-10W/LED

WALR-10W/LED

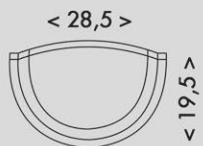

STAR efekt



NOVINKA  
LED

STELA  
A+

24W 1900lm



WKMC450-24W/LED

WKMC450-24W/LED



60W 4600lm



WKMC570-60W/LED

WKMC570-60W/LED

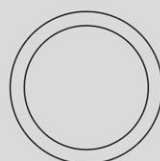

24W - 45,0  
60W - 57,0



24W - 11,0  
60W - 12,0



3000K



4200K



6500K

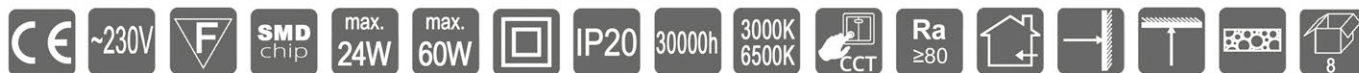



# BYTOVÁ SVÍTLA

## BYTOVÉ SVIETIDLÁ

NOVINKA  
LED

ATMOS  
A+



25W **2200lm**



WAT380-25W/LED

60W **4500lm**



WAT500-60W/LED

WAT380-25W/LED



WAT500-60W/LED

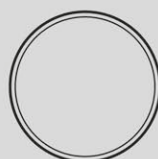

25W - 38,0  
60W - 50,0

> 9,0  
< 9,0



NOVINKA  
LED

DIAMANT  
A+



25W - 34,5  
50W - 50,0  
80W - 80,0



25W - 6,5  
50W - 7,5  
80W - 10,0

25W 2100lm



WZSD-25W/LED

50W 4100lm



WZSD-50W/LED

80W 7300lm



WZSD-80/80W/LED



WZSD-25W/LED



8 590 849 521870

WZSD-50W/LED



8 590 849 521894

WZSD-80/80W/LED



8 590 849 526165



STAR efekt



25W=8
 50W=4
 80W=2

LED

DIAMANT  
A+

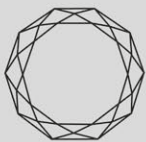

24W - 40,0  
36W - 51,0



24W - 8,0  
36W - 8,5

24W 1860lm



WZSD05-24W/LED

36W 2800lm



WZSD05-36W/LED

WZSD05-24W/LED



8 590 849 525540

WZSD05-36W/LED



8 590 849 525564



STAR efekt



6



**LED****BELA****A+**11W **1100lm**

WD002-11W/LED

22W **2100lm**

WD002-22W/LED

WD002-11W/LED



8 590 849 15 154 73

WD002-22W/LED

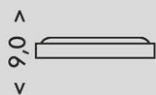
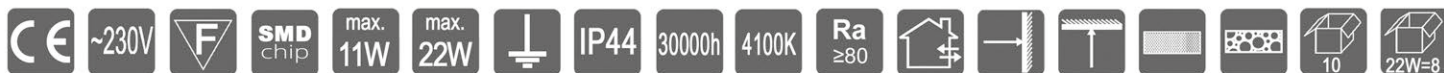

8 590 849 15 155 03

11W - 27,0x27,0  
22W - 37,0x37,0**LED****BELA 2****A+**11W **1100lm**

WD002-11W/LED/HF

22W **2100lm**

WD002-22W/LED/HF

WD002-11W/LED/HF



8 590 849 15 212 45

WD002-22W/LED/HF

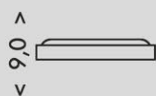
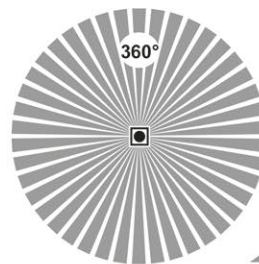

8 590 849 15 212 69

11W - 27,0x27,0  
22W - 37,0x37,0HF senzor detekuje pohyb i přes sklo  
a lehké stavební materiály.LIGHT: S1, S2  
(intenzita světla)

10lux-1000lux

TIME: S3, S4  
(čas)

8s-12min

DIST: S5, S6  
(vzdálenost)

3m-12m



LED

SATURN

A+

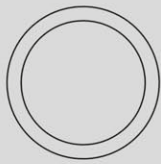

18W - 40,0  
24W - 45,0



18W - 8,0  
24W - 8,5

18W 1080lm



WS009-18W/LED

24W 1680lm



WS009-24W/LED

WS009-18W/LED



8 590 849 45 256 25

WS009-24W/LED



8 590 849 45 256 49



STAR efekt

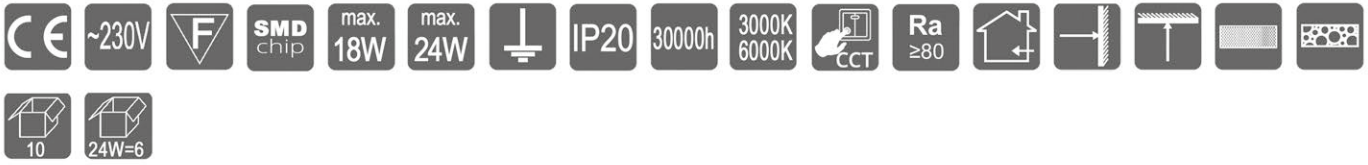

NOVINKA

LED

SATURN

A+

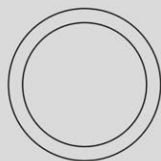

Ø - 78,0



> 8,0  
<

60W 4500lm



WS009-60W/LED

WS009-60W/LED



8 590 849 45 275 75



STAR efekt





## BYTOVÁ SVÍTLA

### BYTOVÉ SVIETIDLÁ

LED

RACHEL  
A+

WS002-100/80W/LED

80W 7200lm



81590884915254891



WS002-100/80W/LED

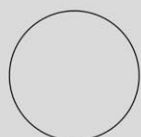
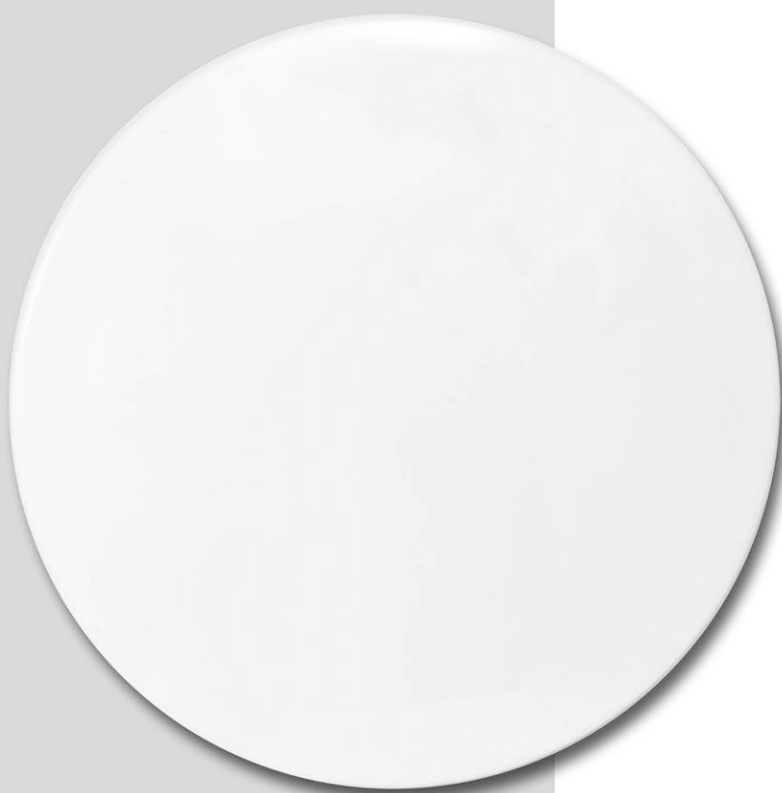

Ø 100,0

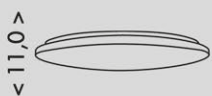

< 11,0 >





LED

RACHEL STAR

A+



60W 5400lm



WS003-80/60W/LED

80W 7200lm



WS003-100/80W/LED

WS003-80/60W/LED



8 590 849 525526

WS002-100/80W/LED



8 590 849 525502



STAR efekt

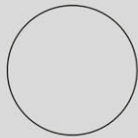

60W - 80,0  
80W - 100,0



60W - 10,0  
80W - 10,0



LED

RACHEL STAR

A+



36W 2800lm



WS003-36W/LED/B

WS003-36W/LED/B



8 590 849 525663



STAR efekt

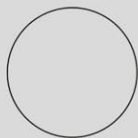

Ø 51,0



< 8,5 >





## BYTOVÁ SVÍTLA

### BYTOVÉ SVIETIDLÁ

LED

ELIS  
A+



880lm



WY002-11W/LED

1740lm



WY002-22W/LED

WY002-11W/LED



WY002-22W/LED



WY002-11W/LED 28,0x28,0  
WY002-22W/LED 38,0x38,0



WY002-11W/LED 9,0  
WY002-22W/LED 10,0



**REFLEKTORY**  
REFLEKTORY







# REFLEKTORY

## REFLEKTORY

NOVINKA

LED

5 LET  
GARANCE

A++  
CLASS  
SMD CHIPSET

INDUSTRY

A++



100W 13500lm



HB03-100W

150W 20250lm



HB03-150W

200W 27000lm



HB03-200W

HB03-100W



HB03-150W



HB03-200W

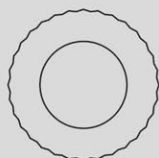
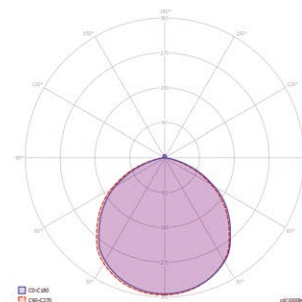

Ø 26,6

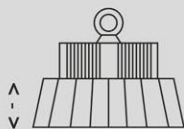

100W < 18,6 >  
150W < 18,6 >  
200W < 20,3 >



> 100,0

< 100,0

MW  
MEAN WELL

PHILIPS  
LUMILEDS



NOVINKA

### LENS 60

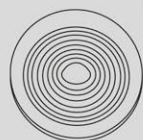

ø 7,5



HB03-LENS60

HB03-LENS60



8 590 849 15 272 54

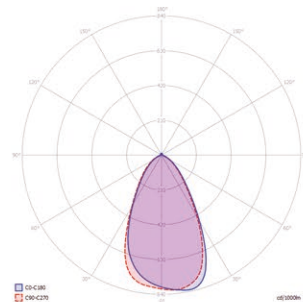

NOVINKA

### LENS 90

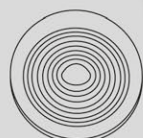

ø 7,5



HB03-LENS90

HB03-LENS90



8 590 849 15 273 15

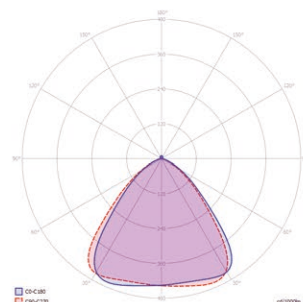

NOVINKA

### HOLDER

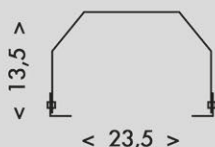
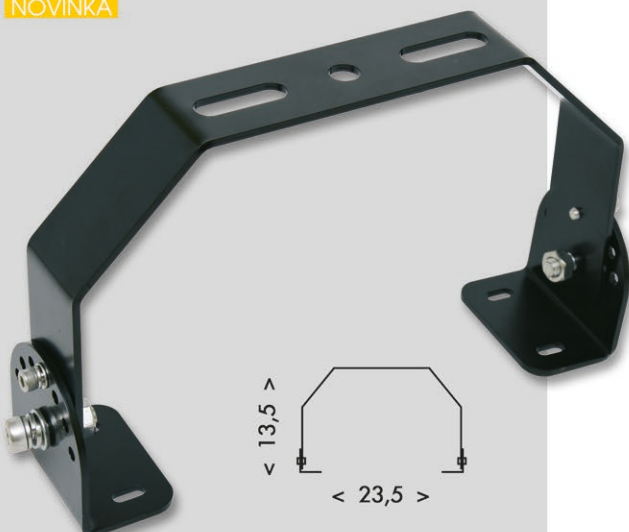

HB03-DRZAK

HB03-DRZAK



8 590 849 15 272 47

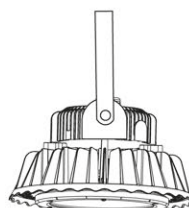



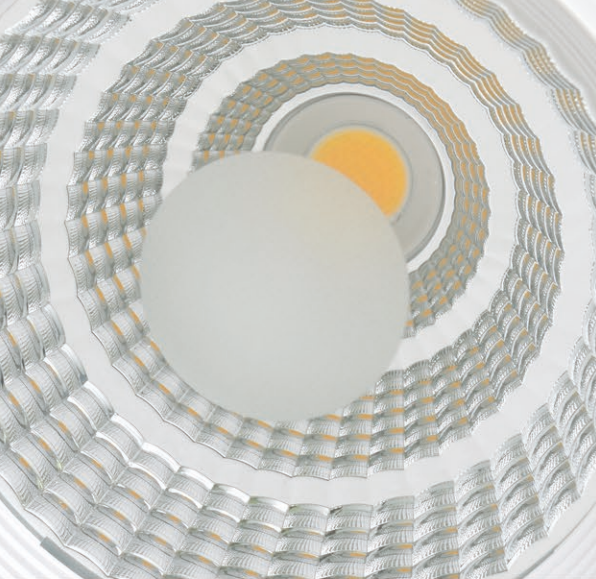

# REFLEKTORY

## REFLEKTORY

NOVINKA

INDUSTRY UGR

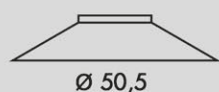

HB03-UGR22

HB03-UGR22



85908494528800

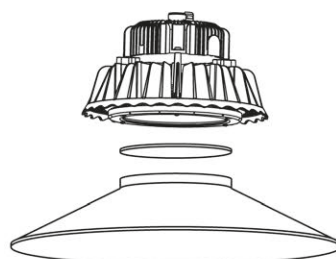

EFFECT  
A+

LED

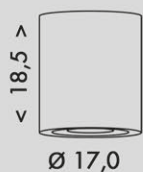

30W 2700lm



MZ-DL-30W/BI

MZ-DL-30W/BI



85908494522303





LED

TRACK

A+

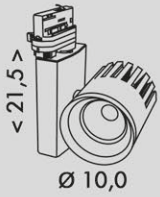

20W 1800lm



TR-TL-20W/BI

30W 2700lm



TR-TL-30W/BI

40W 4000lm



TR-TL-40W/BI

TR-TL-20W/BI



TR-TL-30W/BI



TR-TL-40W/BI

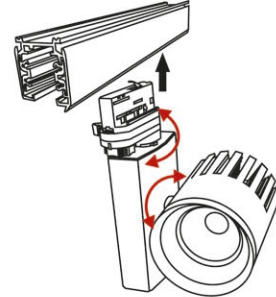

GLOBAL TRACK SYSTEM



NOVINKA

LED

TRACK

A+

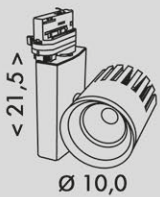

20W 1800lm



TR-TL-20W/CR

30W 2700lm



TR-TL-30W/CR

40W 4000lm



TR-TL-40W/CR

TR-TL-20W/CR



TR-TL-30W/CR



TR-TL-40W/CR

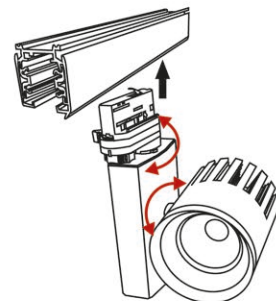

GLOBAL TRACK SYSTEM



NOVINKA

# TRACK



2m



TR-LISTA-3F/BI/2M

2m



TR-LISTA-3F/CR/2M

TR-LISTA-3F/BI/2M



8 590 849 527 001

TR-LISTA-3F/CR/2M



8 590 849 525 441

GLOBAL TRACK SYSTEM



NOVINKA

# TRACK



TR-ADAPT-3F/BI/L



TR-ADAPT-3F/BI/P



TR-ADAPT-3F/CR/L



TR-ADAPT-3F/CR/P

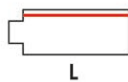

L

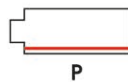

P

TR-ADAPT-3F/BI/L



8 590 849 528 374

TR-ADAPT-3F/CR/L



8 590 849 528 398

TR-ADAPT-3F/BI/P



8 590 849 527 070

TR-ADAPT-3F/CR/P



8 590 849 525 120

GLOBAL TRACK SYSTEM



NOVINKA

# TRACK



TR-SPOJKA/L-3F/BI/L



TR-SPOJKA/L-3F/BI/P



TR-SPOJKA/L-3F/CR/L



TR-SPOJKA/L-3F/CR/P

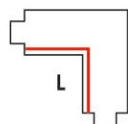

L

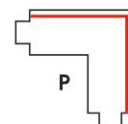

P

TR-SPOJKA/L-3F/BI/L



8 590 849 528 411

TR-SPOJKA/L-3F/CR/L



8 590 849 528 435

TR-SPOJKA/L-3F/BI/P



8 590 849 527 179

TR-SPOJKA/L-3F/CR/P



8 590 849 525 458

GLOBAL TRACK SYSTEM



NOVINKA

TRACK

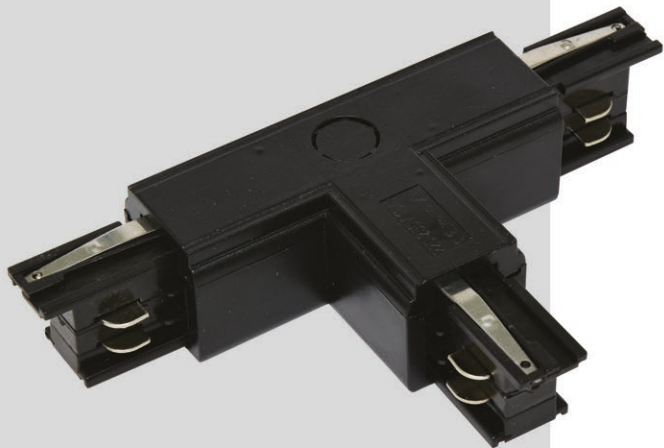

TR-SPOJKA/T-3F/BI/L1



TR-SPOJKA/T-3F/BI/P1



TR-SPOJKA/T-3F/CR/L1



TR-SPOJKA/T-3F/CR/P1



TR-SPOJKA/T-3F/BI/L2



TR-SPOJKA/T-3F/BI/P2



TR-SPOJKA/T-3F/CR/L2



TR-SPOJKA/T-3F/CR/P2

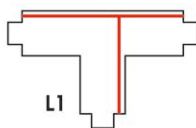

L1

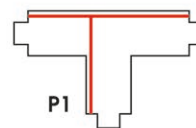

P1

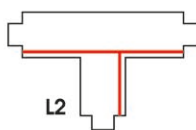

L2

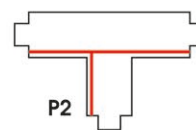

P2

TR-SPOJKA/T-3F/BI/L1



85908491528459

TR-SPOJKA/T-3F/CR/L1



85908491528473

TR-SPOJKA/T-3F/BI/P1



85908491528534

TR-SPOJKA/T-3F/CR/P1



85908491528558

TR-SPOJKA/T-3F/BI/L2



85908491528497

TR-SPOJKA/T-3F/CR/L2



85908491528510

TR-SPOJKA/T-3F/BI/P2



85908491527094

TR-SPOJKA/T-3F/CR/P2



85908491525465

GLOBAL TRACK SYSTEM



NOVINKA

TRACK

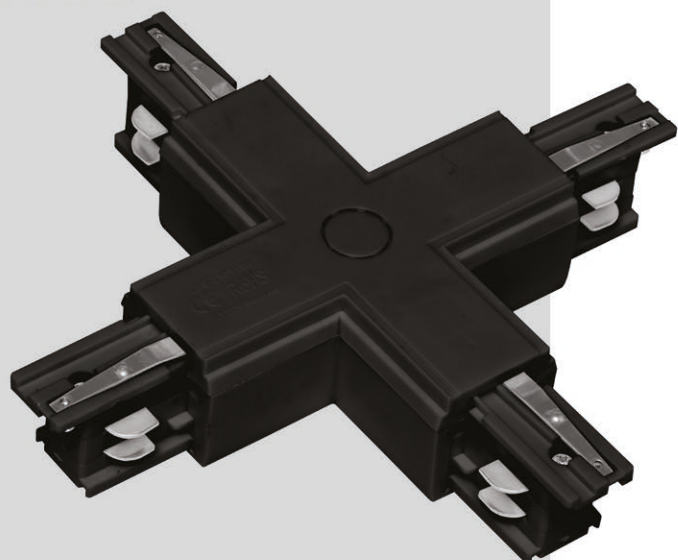

TR-SPOJKA/X-3F/BI



TR-SPOJKA/X-3F/CR

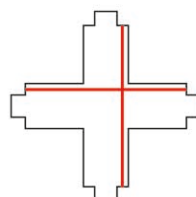

TR-SPOJKA/X-3F/BI



85908491528695

TR-SPOJKA/X-3F/CR



85908491528718

GLOBAL TRACK SYSTEM





NOVINKA

TRACK



TR-SPOJKA-3F/BI



TR-SPOJKA-3F/CR

TR-SPOJKA-3F/BI



TR-SPOJKA-3F/BI



GLOBAL TRACK SYSTEM



NOVINKA

TRACK



TR-KONCOVKA-3F/BI



TR-KONCOVKA-3F/CR

TR-KONCOVKA-3F/BI



TR-KONCOVKA-3F/CR



GLOBAL TRACK SYSTEM



NOVINKA

TRACK



TR-ZAVES/BI



TR-ZAVES/CR

TR-ZAVES/BI



TR-ZAVES/CR



GLOBAL TRACK SYSTEM



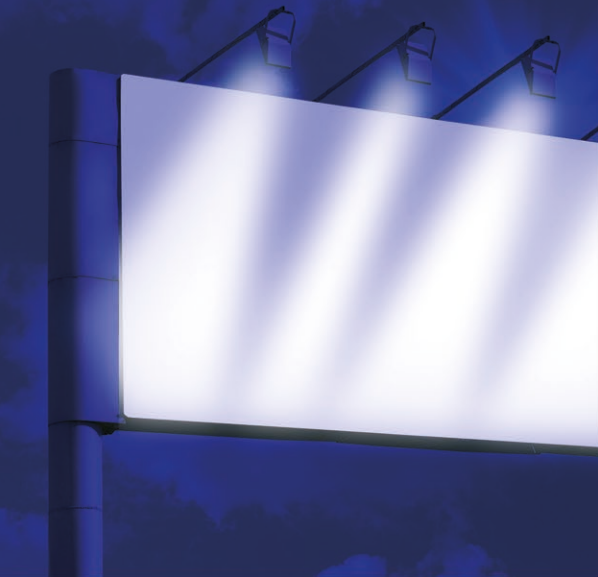

# REFLEKTORY

## REFLEKTORY

NOVINKA  
LED

EXTRA  
A+

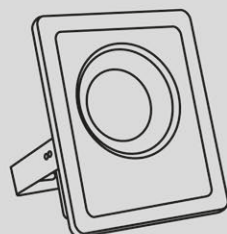

100W 30,0 x 9,0cm x 35,0  
200W 35,0 x 11,0cm x 42,0

100W **8000lm**



RFLN01-100W

200W **16000lm**



RFLN01-200W

RFLN01-100W



RFLN01-200W





30W **2400lm**



RMLED-30W/ORA

100W **8000lm**



RMLED-100W/ORA

50W **4000lm**



RMLED-50W/ORA

RMLED-30W/ORA



RMLED-50W/ORA



RMLED-100W/ORA



30W **2400lm**



RMLED-30W/STJ/ORA

RMLED-30W/STJ/ORA

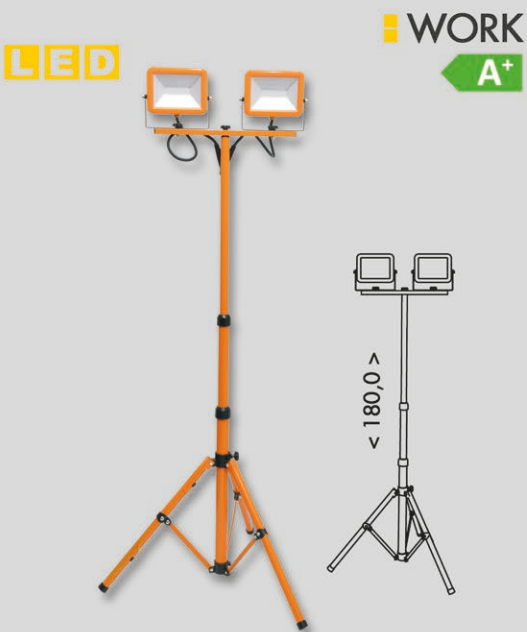

2x 30W **4800lm**



RMLED-2x30W/STJ/ORA

RMLED-2x30W/STJ/ORA





LED

GARY AKU

A+



20W 1400lm



RC020-20W/AKU

RC020-20W/AKU



AKU



MATBAT-RC020

MATBAT-RC020



LED

SLIM AKU

A+



20W 1400lm



RLG402-20W/AKU

RLG402-20W/AKU



**LED****STAR****A+**

	š	h	v
10W	10,5	6,5	8,5
20W	12,5	8,5	10,5
30W	16,0	8,5	12,5
50W	20,5	11,0	16,0
100W	27,0	14,0	20,0

10W **800lm**

RLED48WL-10W

50W **4100lm**

RLED48WL-50W

20W **1600lm**

RLED48WL-20W

100W **7500lm**

RLED48WL-100W

30W **2400lm**

RLED48WL-30W

RLED48WL-10W



RLED48WL-20W



RLED48WL-30W



RLED48WL-50W



RLED48WL-100W



ventilační membrána

**LED****STAR****A+**

	š	h	v
10W	10,5	6,5	14,5
20W	12,5	8,5	16,5
30W	16,0	8,5	18,5
50W	20,5	11,0	22,0

10W **800lm**

RLED48WL-10W/PIR

30W **2400lm**

RLED48WL-30W/PIR

20W **1600lm**

RLED48WL-20W/PIR

50W **4100lm**

RLED48WL-50W/PIR

RLED48WL-10W/PIR



RLED48WL-20W/PIR



RLED48WL-30W/PIR



RLED48WL-50W/PIR





# REFLEKTORY

## REFLEKTORY

 **STOJAN**

**R-STOJAN**



R-STOJAN

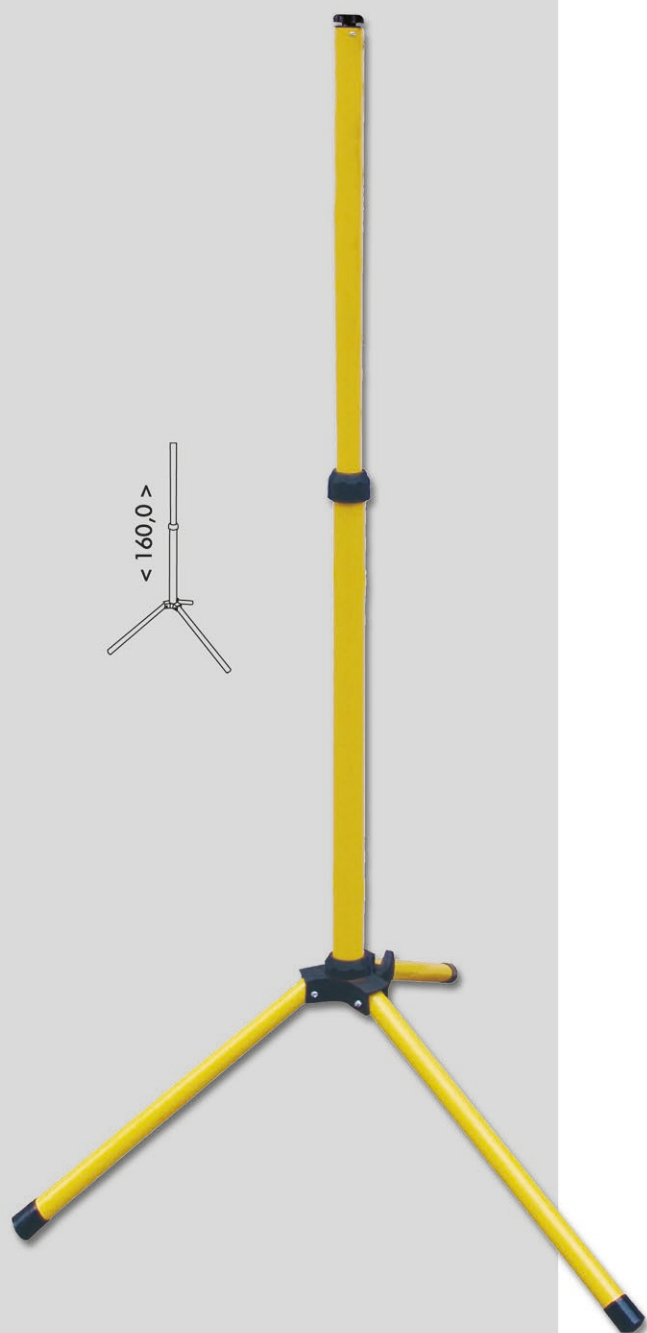
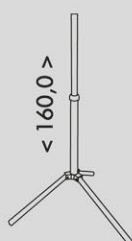



LED

UFO

A+

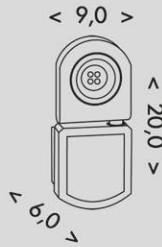

10W 720lm



RL3226-10W



RL3226-10W

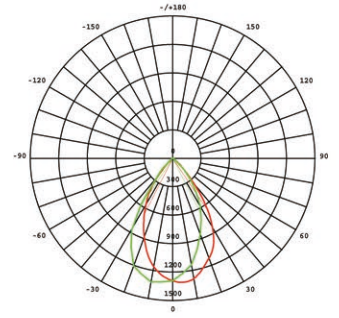

~230V



SMD chip

max. 10W



IP54

30000h

6400K

Ra  $\geq 80$



LED

UFO

A+

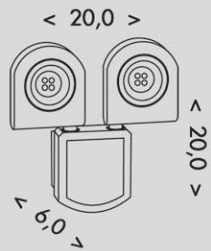

20W 1440lm



RL3226-2x10W



RL3226-2x10W

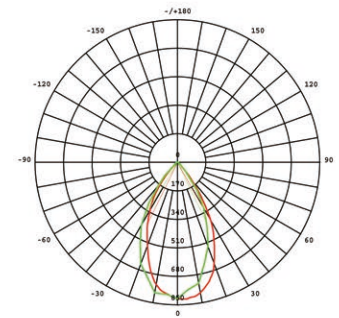

~230V



SMD chip

max. 20W



IP54

30000h

6400K

Ra  $\geq 80$



LED

UFO

A+

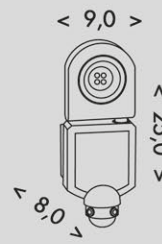

10W 720lm



RL3226S-10W



RL3226S-10W

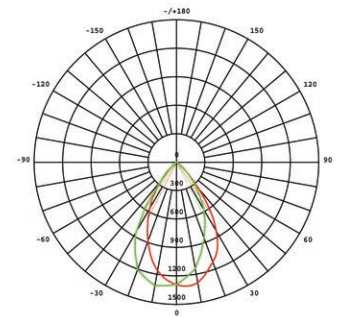

~230V



SMD chip

max. 10W



PIR senzor



12m

IP54

30000h

6400K

Ra  $\geq 80$



# SVĚTELNÉ ZDROJE

SVETELNÉ ZDROJE





# SVĚTELNÉ ZDROJE

## SVETELNÉ ZDROJE

LED

SMD E27

A<sup>+</sup>

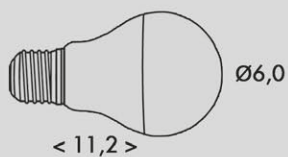

470lm



LED5W-A60/E27/3000

500lm



LED5W-A60/E27/4200

LED5W-A60/E27/3000



8 590 849 15 107 99

LED5W-A60/E27/4200



8 590 849 15 108 12



LED

SMD E27

A<sup>+</sup>

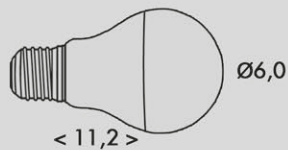

750lm



LED8W-A60/E27/3000

810lm



LED8W-A60/E27/4200

LED8W-A60/E27/3000



8 590 849 15 139 81

LED8W-A60/E27/4200



8 590 849 15 140 01





LED

SMD E27

A+

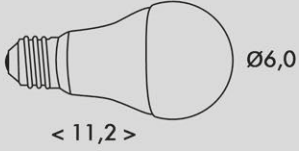

980lm



LED10W-A60/E27/3000

1050lm



LED10W-A60/E27/4200

LED10W-A60/E27/3000



LED10W-A60/E27/4200



LED

SMD E27

A+

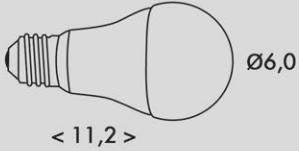

1210lm



LED12W-A60/E27/3000

1270lm



LED12W-A60/E27/4200

LED12W-A60/E27/3000



LED12W-A60/E27/4200



LED

SMD E27

A+

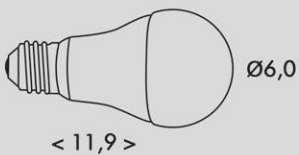

1520lm



LED15W-A60/E27/2700

1590lm



LED15W-A60/E27/4100

LED15W-A60/E27/2700



LED15W-A60/E27/4100



NOVINKA  
LED

SMD E27

A+

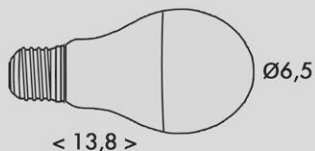

2000lm



LED20W-A65/E27/2700

2100lm



LED20W-A65/E27/4100

LED20W-A65/E27/2700



8 590 849 528947

LED20W-A65/E27/4100



8 590 849 528978



LED

SMD G45

A+

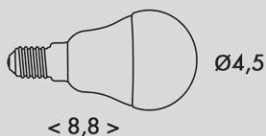

420lm



LED5W-G45/E14/2700

440lm



LED5W-G45/E14/4100

LED5W-G45/E14/2700



8 590 849 515152

LED5W-G45/E14/4100



8 590 849 515169



LED

SMD G45

A+

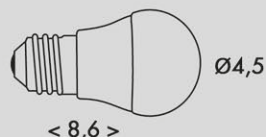
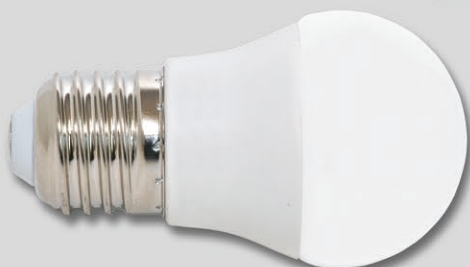

420lm



LED5W-G45/E27/2700

440lm



LED5W-G45/E27/4100

LED5W-G45/E27/2700



8 590 849 517736

LED5W-G45/E27/4100



8 590 849 517743





## SVĚTELNÉ ZDROJE

### SVETELNÉ ZDROJE

**LED**

**SMD G45**

**A+**

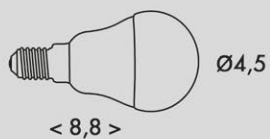

**590lm**



LED7W-G45/E14/2700

**630lm**



LED7W-G45/E14/4100

LED7W-G45/E14/2700



LED7W-G45/E14/4100



**LED**

**SMD G45**

**A+**

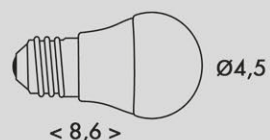
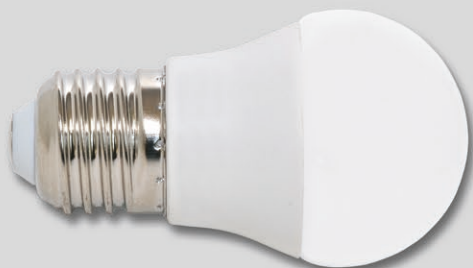

**590lm**



LED7W-G45/E27/2700

**630lm**



LED7W-G45/E27/4100

LED7W-G45/E27/2700



LED7W-G45/E27/4100





LED

SMD C37

A+

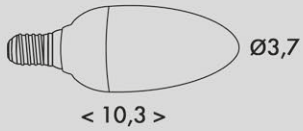

420lm



LED5W-SV/E14/2700

440lm



LED5W-SV/E14/4100

LED5W-SV/E14/2700



LED5W-SV/E14/4100



LED

SMD C37

A+

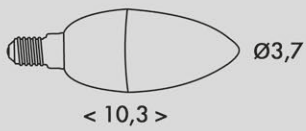

590lm



LED7W-SV/E14/2700

630lm



LED7W-SV/E14/4100

LED7W-SV/E14/2700



LED7W-SV/E14/4100



LED

SMD R50

A+

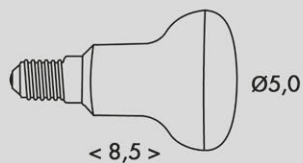

610lm



LED6,5W-E14/R50/3000

650lm



LED6,5W-E14/R50/4200

LED6,5W-E14/R50/3000



LED6,5W-E14/R50/4200



LED

SMD GU10

A+

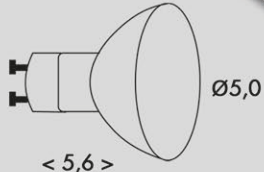

470lm



LED5W-GU10/2700

490lm



LED5W-GU10/4100

LED5W-GU10/2700



8 590 849 515538

LED5W-GU10/4100



8 590 849 515817



LED

SMD GU10

A+

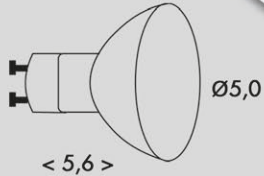

710lm



LED7,5W-GU10/2700

750lm



LED7,5W-GU10/4100

LED7,5W-GU10/2700



8 590 849 514261

LED7,5W-GU10/4100



8 590 849 514230



LED

SMD GU10

A+

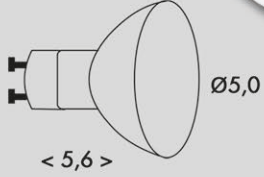

980lm



LED10W-GU10/2700

1020lm



LED10W-GU10/4100

LED10W-GU10/2700



8 590 849 519778

LED10W-GU10/4100



8 590 849 519785



LED

SMD MR16

A+

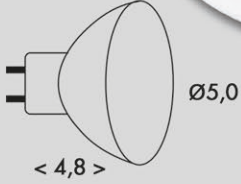

470lm



LED5W-MR16/2700

490lm



LED5W-MR16/4100

LED5W-MR16/2700



8 590 849 525267

LED5W-MR16/4100



8 590 849 525250



LED

FRIGO LED

A+



2W <6,0>  
4W <8,3>

120lm



LED2W-TR/E14/4000

360lm



LED4W-TR/E14/4000

LED2W-TR/E14/4000



8 590 849 510775

LED4W-TR/E14/4000



8 590 849 523003



LED

LED G9

A+



<6,2>

350lm



LED4,5W-G9/3000

370lm



LED4,5W-G9/4200

LED4,5W-G9/3000



8 590 849 517231

LED4,5W-G9/4200



8 590 849 517248





NOVINKA  
LED

COB G4  
A+

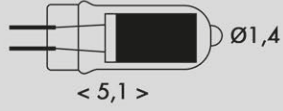

LED2,5W-G4/2700



LED2,5W-G4/4100

LED2,5W-G4/2700



8 590 849 528886

LED2,5W-G4/4100



8 590 849 528916



NOVINKA  
LED

SMD E27  
A+

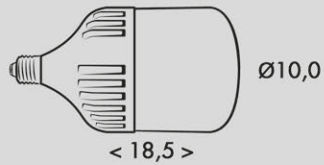

LED30W-E27/5000

LED30W-E27/5000



8 590 849 526936



NOVINKA  
LED

SMD E40  
A+



50W Ø11,8 < 23,0 >  
95W Ø15,0 < 27,3 >  
150W Ø15,8 < 28,6 >



LED50W-E40/5000



LED150W-E40/5000



LED95W-E40/5000

LED50W-E40/5000



8 590 849 524840

LED95W-E40/5000



8 590 849 524864

LED150W-E40/5000



8 590 849 526950



LED

SMD TUBE

A+



Ø2,6

9W < 60,4 >

900lm

LEDTUBE-60/9W/4000/M

20W < 121,4 >

1600lm

LEDTUBE-120/20W/4000/M

24W < 151,4 >

2200lm

LEDTUBE-150/24W/4000/M



LEDTUBE-60/9W/4000/M



8 590 849 15 144 14

LEDTUBE-120/20W/4000/M



8 590 849 15 140 87

LEDTUBE-150/24W/4000/M



8 590 849 15 140 94



LED

SMD TUBE

A+

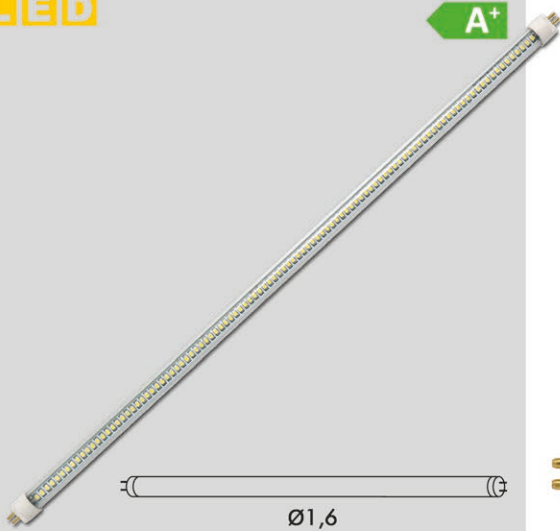

Ø1,6

4W < 30,2 >

AC/DC-12V-300mA

300lm

LEDTUBE-T5-30/4W/4100/C

8W < 53,1 >

AC/DC-18V-340mA

700lm

LEDTUBE-T5-53/8W/4100/C

13W < 86,4 >

AC/DC-54V-160mA

1300lm

LEDTUBE-T5-86/13W/4100/C



LEDTUBE-T5-30/4W/4100/C



8 590 849 15 249 01

LEDTUBE-T5-53/8W/4100/C



8 590 849 15 249 25

LEDTUBE-T5-86/13W/4100/C



8 590 849 15 249 49



LED

SMD TUBE

A+

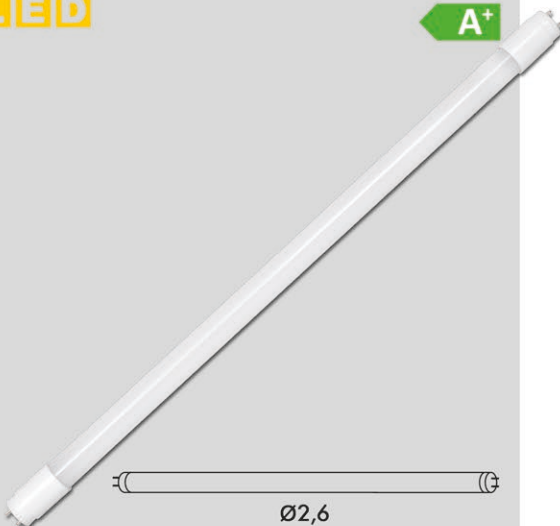

Ø2,6

10W < 60,4 >

800lm

LEDTUBE-S-60/10W/4200

20W < 121,4 >

1600lm

LEDTUBE-S-120/20W/4200

24W < 151,4 >

2100lm

LEDTUBE-S-150/24W/4200



LEDTUBE-S-60/10W/4200



8 590 849 15 204 91

LEDTUBE-S-120/20W/4200



8 590 849 15 205 21

LEDTUBE-S-150/24W/4200



8 590 849 15 205 14



DZ  
A

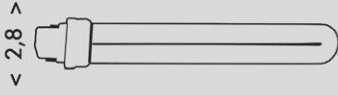

9W < 16,5 >



DZ-09

11W < 23,5 >



DZ-11

DZ-09



DZ-11



TUBE16/841  
A

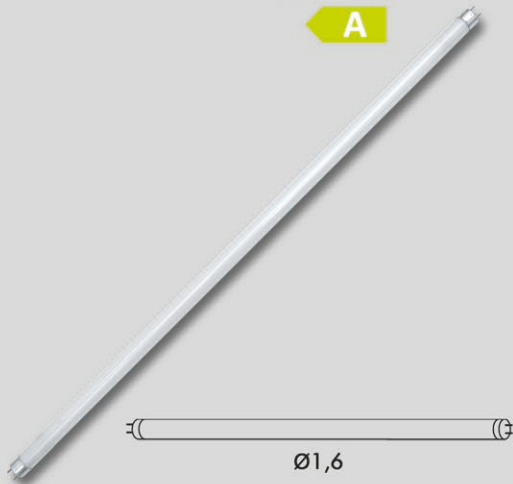

8W < 30,2 >



TUBE16-08/841/EU

13W < 53,1 >



TUBE16-13/841/EU

21W < 86,4 >



TUBE16-21/841/EU

TUBE16-08/841/EU



TUBE16-13/841/EU



TUBE16-21/841/EU



TUBE26/841  
A



10W < 34,5 >



TUBE26-10/841/EU

15W < 45,1 >



TUBE26-15/841/EU

18W < 60,4 >



TUBE26-18/841/EU

36W < 121,4 >



TUBE26-36/841/EU

TUBE26-10/841/EU



TUBE26-15/841/EU



TUBE26-18/841/EU



TUBE26-36/841/EU





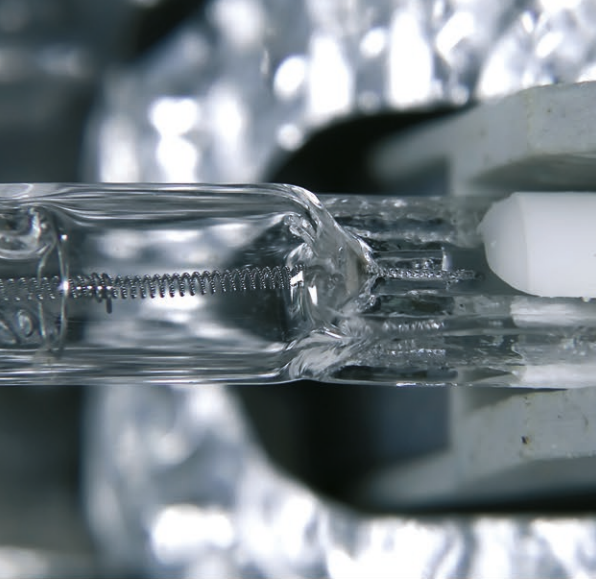

# SVĚTELNÉ ZDROJE

## SVETELNÉ ZDROJE

ECO J

C

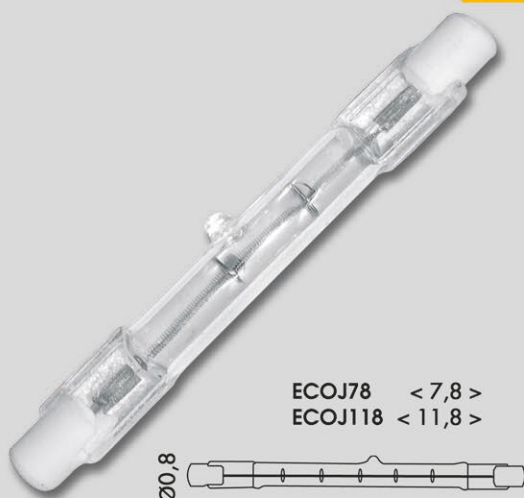

ECOJ78 < 7,8 >  
ECOJ118 < 11,8 >

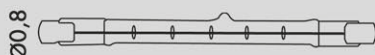

80W **1400lm**



ECOJ78/80W

120W **2200lm**



ECOJ78/120W

400W **8800lm**



ECOJ118/400W

ECOJ78/80W



ECOJ78/120W



ECOJ118/400W



J

D

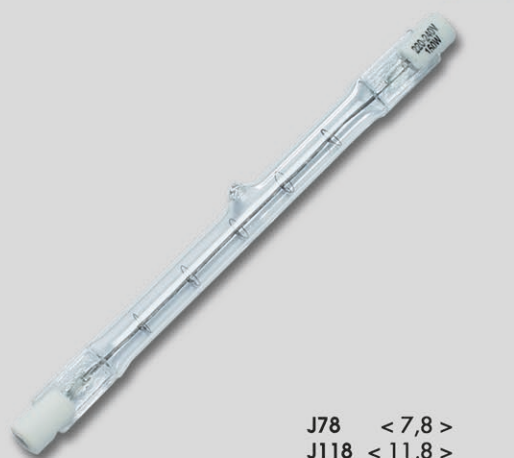

J78 < 7,8 >  
J118 < 11,8 >  
J189 < 18,9 >



100W **1600lm**



J100-78

150W **2400lm**



J150-78

150W **2400lm**



J150-118

300W **5400lm**



J300-118

500W **10000lm**



J500-118

1000W **21000lm**



J1000-189

J100-78



J150-78



J150-118



J300-118



J500-118



J1000-189





# SVĚTELNÉ ZDROJE

## SVETELNÉ ZDROJE

JC  
D

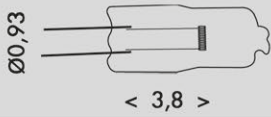

- G4/10W 140lm  
JC-10/G4
- G4/20W 350lm  
JC-20/G4



G9  
D

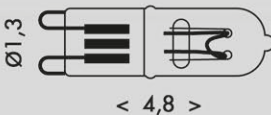
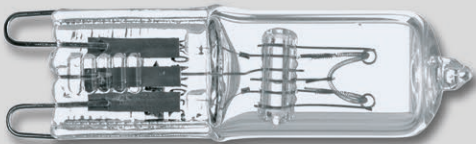

- 25W 180lm  
G9-25CIR
- 40W 360lm  
G9-40CIR
- 60W 600lm  
G9-60CIR





# SVĚTELNÉ ZDROJE

## SVETELNÉ ZDROJE

**GU10**  
**D**

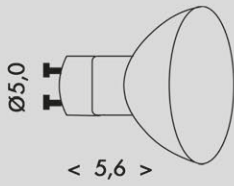

20W **400cd**



GU10-20

35W **600cd**



GU10-35

50W **1000cd**



GU10-50

GU10-20



GU10-35



GU10-50



**R**  
**E**

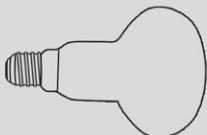

R50 - Ø5,0 < 8,3 >  
R63 - Ø6,3 < 10,3 >

**300lm**



R50E14/25

**400lm**



R50E14/40

**500lm**



R63E27/40

**750lm**



R63E27/60

R50E14/25



R50E14/40



R63E27/40



R63E27/60







## SVĚTELNÉ ZDROJE

### SVETELNÉ ZDROJE

FRIGO

E



E14/15-TR/EU - Ø2,0 < 5,1 >  
E14/40-TR/EU - Ø2,5 < 8,1 >

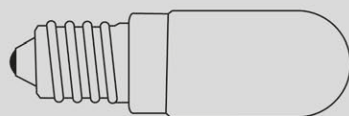

15W 150lm



E14/15-TR/EU

40W 400lm



E14/40-TR/EU

E14/15-TR/EU



E14/40-TR/EU



ELEKTROMATERIÁL  
ELEKTROMATERIÁL

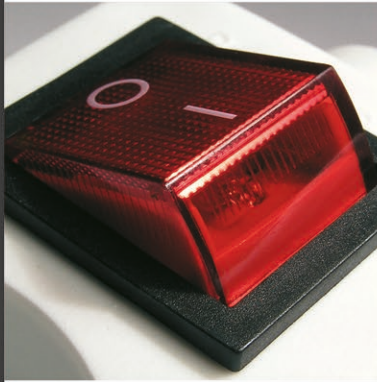

## FK3



FK3-1.5 < 150,0 >  
 FK3-3 < 300,0 >  
 FK3-5 < 500,0 >

1,5m



FK3-1.5

3,0m



FK3-3

5,0m



FK3-5

FK3-1.5



8 590849 315103

FK3-3



8 590849 330106

FK3-5



8 590849 350104



## FK4



FK4-1.5 < 150,0 >  
 FK4-3 < 300,0 >  
 FK4-5 < 500,0 >

1,5m



FK4-1.5

3,0m



FK4-3

5,0m



FK4-5

FK4-1.5



8 590849 415100

FK4-3



8 590849 430103

FK4-5



8 590849 445010



## FK5



FK5-1.5 < 150,0 >  
 FK5-3 < 300,0 >  
 FK5-5 < 500,0 >

1,5m



FK5-1.5

3,0m



FK5-3

5,0m



FK5-5

FK5-1.5



8 590849 515107

FK5-3



8 590849 530100

FK5-5



8 590849 550108





## FX3



FX3-1.5 < 150,0 >  
 FX3-3 < 300,0 >  
 FX3-5 < 500,0 >  
 FX3-7 < 700,0 >  
 FX3-10 < 1000,0 >



FX3-1.5



7,0m

FX3-7



3,0m

FX3-3



10,0m

FX3-10

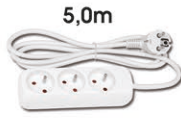

5,0m

FX3-5

FX3-1.5



8 590849 315004

FX3-3



8 590849 330007

FX3-5



8 590849 350005

FX3-7



8 590849 370003

FX3-10



8 590849 310009



## FX4



FX4-1.5 < 150,0 >  
 FX4-3 < 300,0 >  
 FX4-5 < 500,0 >



1,5m

FX4-1.5



3,0m

FX4-3



5,0m

FX4-5

FX4-1.5



8 590849 415001

FX4-3



8 590849 430004

FX4-5



8 590849 450002



## FX5

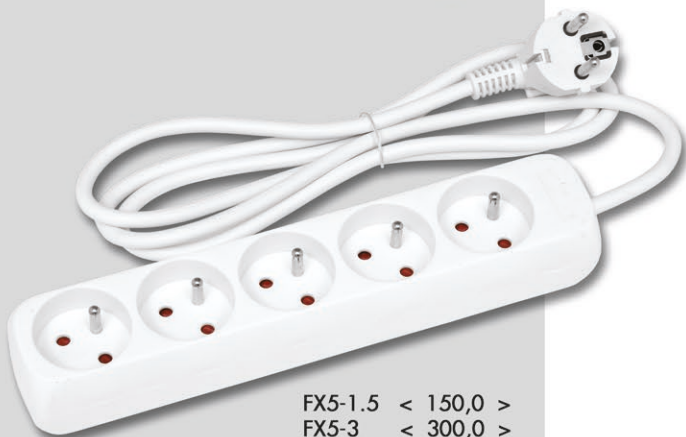

FX5-1.5 < 150,0 >  
 FX5-3 < 300,0 >  
 FX5-5 < 500,0 >  
 FX5-7 < 700,0 >

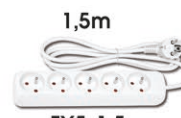

1,5m

FX5-1.5



7,0m

FX5-7

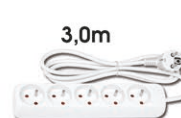

3,0m

FX5-3

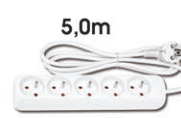

5,0m

FX5-5

FX5-1.5



8 590849 515008

FX5-3



8 590849 530001

FX5-5



8 590849 550009

FX5-7



8 590849 570007





# ELEKTROMATERIÁL

## ELEKTROMATERIÁL

### FX1



FX1-2	<	200,0	>
FX1-3	<	300,0	>
FX1-5	<	500,0	>
FX1-7	<	700,0	>
FX1-10	<	1000,0	>



2,0m

FX1-2



3,0m

FX1-3



5,0m

FX1-5



7,0m

FX1-7



10,0m

FX1-10

FX1-2



8 590849 1102000

FX1-3



8 590849 1103007

FX1-5



8 590849 1105001

FX1-7



8 590849 1107005

FX1-10



8 590849 1110005



### FX1



FX1-15	<	1500,0	>
FX1-20	<	2000,0	>
FX1-25	<	2500,0	>
FX1-30	<	3000,0	>



15,0m

FX1-15



20,0m

FX1-20



25,0m

FX1-25



30,0m

FX1-30

FX1-15



8 590849 4501520

FX1-20



8 590849 1120004

FX1-25



8 590849 1125009

FX1-30



8 590849 4501537





# ELEKTROMATERIÁL

## ELEKTROMATERIÁL

**FX1**



25,0m

FX1-25 3x1,5



30,0m

FX1-30 3x1,5



40,0m

FX1-40 3x1,5

FX1-25 3x1,5



8 590849 1126006

FX1-30 3x1,5



8 590849 1501544

FX1-40 3x1,5



8 590849 1140002

FX1-25 3x1,5 < 2500,0 >  
 FX1-30 3x1,5 < 3000,0 >  
 FX1-40 3x1,5 < 4000,0 >







# ELEKTROMATERIÁL

## ELEKTROMATERIÁL

**BUBEN**



FBUBEN-25

**FBUBEN-25**



**BUBEN**



FBUBEN-40



FBUBEN-50

**FBUBEN-40**



**FBUBEN-50**





# ELEKTROMATERIÁL

## ELEKTROMATERIÁL

### BUBEN IP44



25m



FBUBEN-25/IP44

FBUBEN-25/IP44



### BUBEN IP44



40m



FBUBEN-40/IP44

FBUBEN-40/IP44



FBUBEN-50/IP44



50m



FBUBEN-50/IP44





# ELEKTROMATERIÁL

## ELEKTROMATERIÁL

### UFON 4

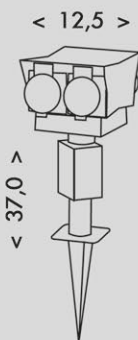

XHWS-F03

XHWS-F03



### UFON 24

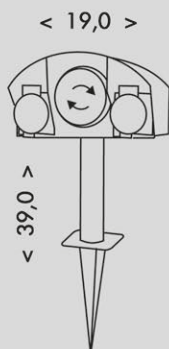

XHWS-F06

XHWS-F06







# ELEKTROMATERIÁL

## ELEKTROMATERIÁL

### SOLITER 24

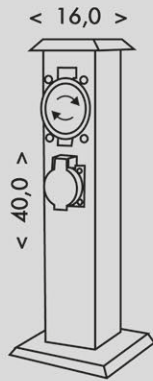

XSMM-202 FT

XSMM-202 FT



### SOLITER 4

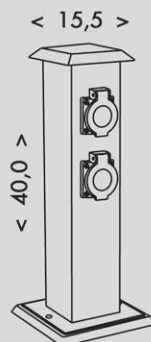

XSMM-204F

XSMM-204F





# ELEKTROMATERIÁL

## ELEKTROMATERIÁL

### STONE 2



XSTA-222GT

XSTA-222GT

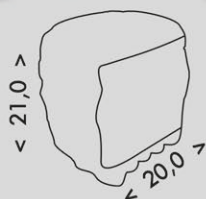

### STONE 4



XSTA-224G

XSTA-224G

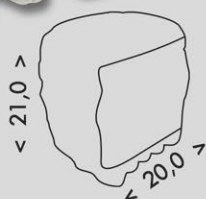

XKFZ



XKFZ-01/2+1T

XKFZ-01/2+1T



XKFZ



XKFZ-01/3T

XKFZ-01/3T



XKFZ B



XKFZB-1/3

XKFZB-1/3







# ELEKTROMATERIÁL

## ELEKTROMATERIÁL

### X-USB

### XJ4U-USB



XJ4U-USB



### XFZBD-01/01

### XFZBD-01/01



XFZBD-01/01



MAX	3680W 16A 250V~
Absorpcie tepelného rázu Absorpcia tepelného rázu	200 J
Svodový prúd Zvodový prúd	8/20uA,4500A,4.5KA
Ochranná úroveň Ochranná úroveň	Uoc 5KV,Up 2KV
Doba odezvy Doba odozvy	<1ms
Vybíjací prúd (jmenovitý) Vybíjací prúd (menovitý)	2,5kA





# ELEKTROMATERIÁL

## ELEKTROMATERIÁL

NOVINKA

 SMOKE

XLX215



XLX215



F1A  
F1B



F1A



F1B

F1A



8 590849 4001907

F1B



8 590849 4001914



DRZAK



F-DRZAK/3



F-DRZAK/5

F-DRZAK/3



8 590849 4492798

F-DRZAK/5



8 590849 4492811



FKID



FKID



FKID



8 590849 500653





### SOCKET E14

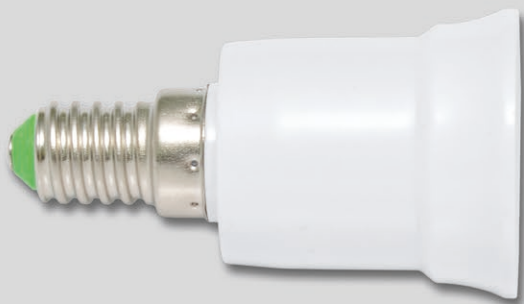

ADAPT-E14/E27

### ADAPT-E14/E27



### SOCKET E14

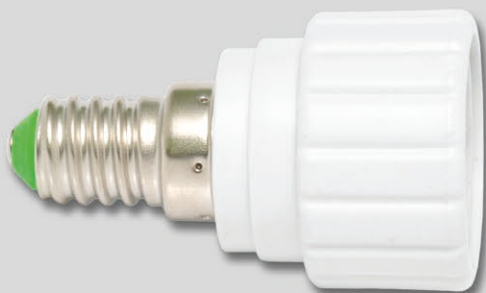

ADAPT-E14/GU10

### ADAPT-E14/GU10



### SOCKET E27

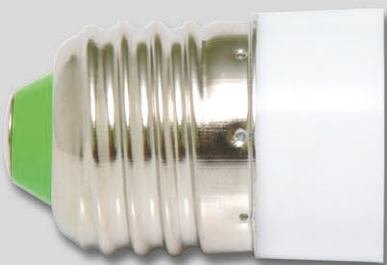

ADAPT-E27/E14

### ADAPT-E27/E14



### SOCKET E27



ADAPT-E27/GU10

### ADAPT-E27/GU10





# ELEKTROMATERIÁL

## ELEKTROMATERIÁL

### TIMER



X2A/1

X2A/1



### DIGI TIMER



XDIG1

XDIG1





# ELEKTROMATERIÁL

## ELEKTROMATERIÁL

### REMOTE



EZ-7901

EZ-7901



85908494506372



### SENZOR 140



ESTO1-BI

ESTO1-BI



85908494504781







# ELEKTROMATERIÁL

## ELEKTROMATERIÁL

### ■ SENZOR 360



EST05-BI

EST05-BI



### ■ SENZOR 360



EST40-BI

EST40-BI





# ELEKTROMATERIÁL

## ELEKTROMATERIÁL

### ■ SENZOR HF



EST701-BI

EST701-BI



### ■ SENZOR 180



EST111-BI

EST111-BI



NOVINKA

# SENZOR

EST129-BI



8 590849 528572



EST129-BI

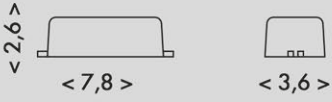

NOVINKA

# SENZOR HAND

EST122-BI



8 590849 528596



EST122-BI

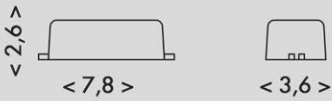

NOVINKA

# SENZOR DOOR

EST123-BI



8 590849 528619



EST123-BI





## SOCKET E27



OBJIMKA-E27

OBJIMKA-E27



## SOCKET E14



OBJIMKA-E14

OBJIMKA-E14



## SOCKET GU10



OBJIMKA-GU10

OBJIMKA-GU10



LED

LED NIGHT

A+



XLED-NL/BI

XLED-NL/BI



LED

LED NIGHT

A+



XESDEN-1W

XESDEN-1W



LED

STAR LED

A+



XP200-LED

XP200-LED



# ZABEZPEČOVACÍ TECHNIKA

---

## ZABEZPEČOVACIA TECHNIKA







## ZABEZPEČOVACÍ TECHNIKA

## ZABEZPEČOVACIA TECHNIKA

XSL1008

XSL1008



-  **Fotopast pro venkovní použití na SD kartu**
- rozlišení snímků až 12 Mpix, zaostření 1,5 m až nekonečno
  - rozlišení videa max. HD 720p, délka každého videa až 10 sec.
  - nahrávání se zvukem
  - obrazový snímač CMOS
  - PIR pohybový senzor s detekcí 60 st až do 20m
  - infračervený LED přisvit pro neviditelné noční snímání
  - podporuje SD karty s max. kapacitou 32 GB, Class 10
  - na snímcích uveden datum / čas/ teplota
  - AV výstup pro připojení k TV
  - stupeň krytí IP65
  - napájení: 8ks AA baterií (nejsou součástí balení)

**Obsah balení:**  
fotopast - záznamové zařízení  
montážní popruh  
propojovací USB kabel  
uživatelská příručka

-  **Fotopasca na vonkajšie použitie na SD kartu**
- rozlišenie snímkov až 12 Mpix, zaostrenie 1,5 m až nekonečno
  - rozlišenie videa max. HD 720p, dĺžka videa až 10 sec.
  - nahrávanie so zvukom
  - obrazový snímač CMOS
  - PIR pohybový senzor s detekciou 60 st až do 20m
  - infračervené LED prísvitovanie pre neviditeľné nočné snímání
  - podporuje SD karty s max. kapacitou 32 GB, Class 10
  - na snímkach uvádza dátum / čas/ teplotu
  - AV výstup na pripojenie k TV
  - stupeň krytia IP65
  - napájanie: 8ks AA batérií (nie sú súčasťou balenia)

**Obsah balenia:**  
fotopasca - záznamové zariadenie  
montážny popruh  
prepájací USB kábel  
uživatelská príručka





## ZABEZPEČOVACÍ TECHNIKA

## ZABEZPEČOVACIA TECHNIKA

DV140

DV140



- Outdoorová 4K kamera na SD kartu, voděodolná (30m) s ultra širokou skleněnou čočkou a vestavěným mikrofonom**
- rozlišení 4K Ultra HD - 30 fps, 16 Mpx, LCD displej
  - na výběr video formáty 4K (30fps) / 1080p (60fps) / 720p (120fps)
  - fotoaparát - různé možnosti režimů focení
  - ukládání záznamu do formátu H.264 MOV
  - podporuje SD karty s max. kapacitou 32 GB, Class 10, min. 30 MB/s
  - HDMI výstup
  - napájení 900 mAh lithium baterie (umožní až 1,5 hod záznamu)
  - WiFi pro připojení k chytrému telefonu nebo tabletu
  - stupeň krytí IP68 (v pouzdru)

**Príslušenství:**

- dálkové ovládání
- voděodolné pouzdro
- různé druhy základů, klipů, 3M páska
- držák pro přichycení k helmě a říditkám
- USB kabel
- síťový adaptér pro dobíjení
- speciální čisticí hadřík
- uživatelská příručka

- Outdoorová 4K kamera na SD kartu, vodotesná (30m) s ultra širokou skleněnou šošovkou a zabudovaným mikrofónom**
- rozlišení 4K Ultra HD - 30 fps, 16 Mpx, LCD displej
  - na výběr video formáty 4K (30fps) / 1080p (60fps) / 720p (120fps)
  - fotoaparát - různé možnosti režimů fotenia
  - ukládanie záznamu do formátu H.264 MOV
  - podporuje SD karty s max. kapacitou 32 GB, Class 10, min. 30 MB/s
  - HDMI výstup
  - napájanie 900 mAh lithium batéria (umožní až 1,5 hod záznamu)
  - WiFi pre pripojenie k smartphonu alebo tabletu
  - stupeň krytia IP68 (v puzdre)

**Príslušenstvo:**

- dialkové ovládanie
- vodotesné puzdro
- rôzne druhy základní, klipov, 3M páska
- držiak na uchytienie k helme alebo bicyklu
- USB kábel
- sieťový adaptér na dobíjanie
- špeciálna čistiacia handrička
- uživatelská príručka







# ZABEZPEČOVACÍ TECHNIKA

## ZABEZPEČOVACIA TECHNIKA

HF-GSM02

HF-GSM02



### Bezdrátový GSM alarm

- velmi snadná a rychlá bezdrátová instalace
- automatické telefonní oznámení alarmu až na 6 čísel
- automatické SMS oznámení alarmu až na 3 čísla
- snadné ovládání systému pomocí dálkových ovladačů
- SOS tlačítko na dálkovém ovladači
- dálkové zapnutí/vypnutí alarmu pomocí mobilního telefonu
- upozornění SMS zprávou na výpadek elektrického proudu
- vestavěný akumulátor pro provoz při výpadku el. proudu
- možnost provedení telefonního hovoru z centrály
- možnost jednoduchého doplnění o další bezdrátové senzory



### Bezdrátový GSM alarm

- veľmi ľahká a rýchla bezdrôtová inštalácia
- automatické telefónne oznámenie alarmu až na 6 čísel
- automatické SMS oznámenie alarmu až na 3 čísla
- ľahké ovládanie systému pomocou diaľkových ovládačov
- SOS tlačítko na diaľkovom ovládači
- Diaľkové zapnutie / vypnutie alarmu pomocou mobilného telefónu
- Upozornenie SMS správou na výpadok elektrického prúdu
- Vstavaný akumulátor na prevádzku pri výpadku elektrického prúdu
- Možnosť vykonania telefónneho hovoru z centrály
- Možnosť jednoduchého doplnenia o ďalšie bezdrôtové senzory



Pohybové čidlo



Okenní senzor



Dveřní senzor

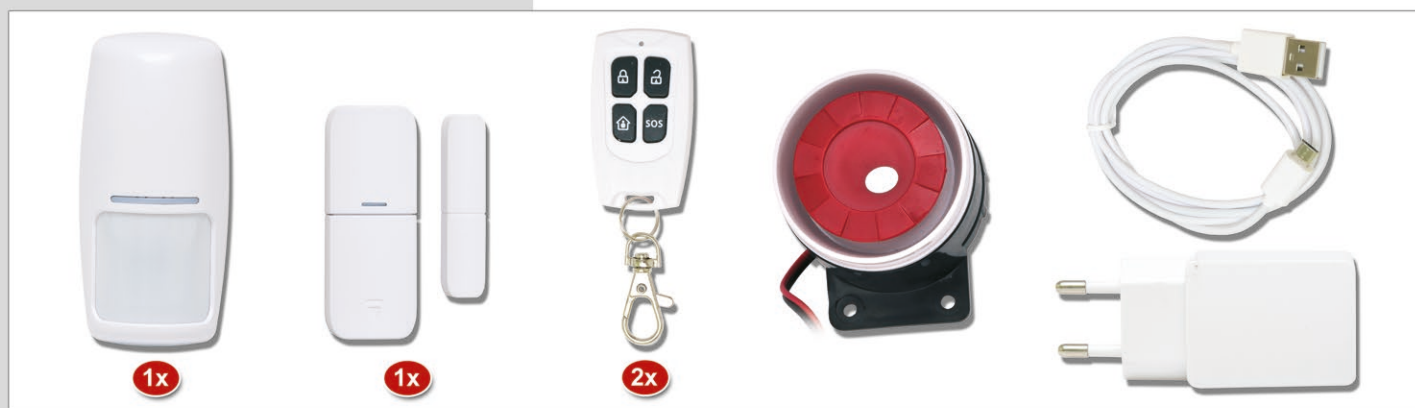





# ZABEZPEČOVACÍ TECHNIKA

## ZABEZPEČOVACIA TECHNIKA

HF-GSM03

HF-GSM03



### Bezdrátový GSM alarm

- velmi snadná a rychlá bezdrátová instalace
- automatické telefonní oznámení alarmu až na 6 čísel
- automatické SMS oznámení alarmu až na 3 čísla
- snadné ovládání systému pomocí dálkových ovladačů
- SOS tlačítko na dálkovém ovladači
- dálkové zapnutí/vypnutí alarmu pomocí mobilního telefonu
- upozornění SMS zprávou na výpadek elektrického proudu
- vestavěný akumulátor pro provoz při výpadku el. proudu
- možnost provedení telefonního hovoru z centrály
- možnost jednoduchého doplnění o další bezdrátové senzory



### Bezdrátový GSM alarm

- veľmi ľahká a rýchla bezdrôtová inštalácia
- automatické telefónne oznámenie alarmu až na 6 čísel
- automatické SMS oznámenie alarmu až na 3 čísla
- ľahké ovládanie systému pomocou diaľkových ovládačov
- SOS tlačítko na diaľkovom ovládači
- Diaľkové zapnutie / vypnutie alarmu pomocou mobilného telefónu
- Upozornenie SMS správou na výpadok elektrického prúdu
- Vstavaný akumulátor na prevádzku pri výpadku elektrického prúdu
- Možnosť vykonania telefónneho hovoru z centrály
- Možnosť jednoduchého doplnenia o ďalšie bezdrôtové senzory



Pohybové čidlo



Okenní senzor



Dveřní senzor

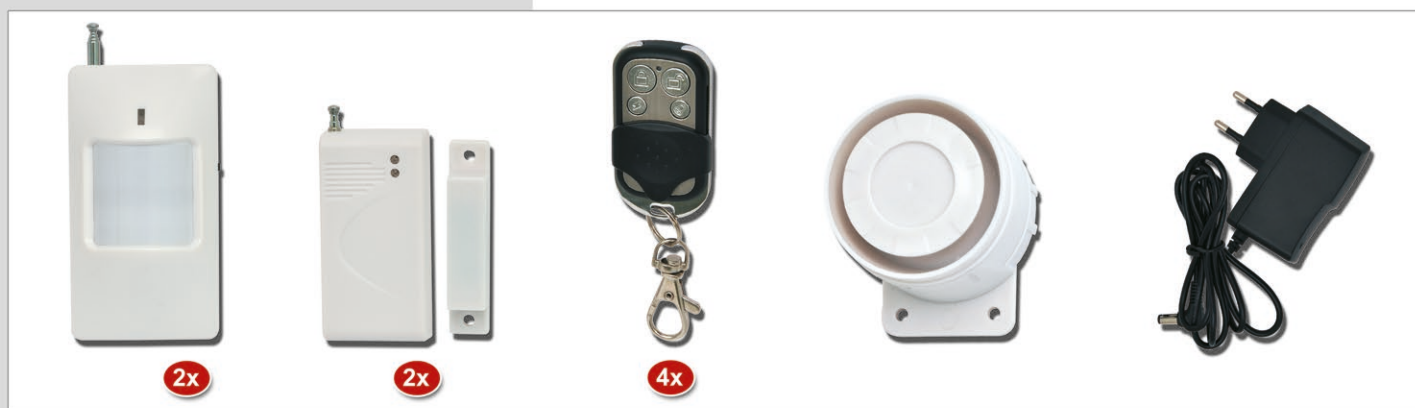

PIR



HF-EST20-BI

HF-EST20-BI



DOOR



HF-25D

HF-25D



KEYPAD



HF-28WK

HF-28WK





# ELEKTROMATERIÁL

## ELEKTROMATERIÁL

 SMOKE



HF-28WS

HF-28WS



85908494509137



 GAS



HF-30WG

HF-30WG



85908494509144





**STOLNÍ LAMPY**  
STOLNÉ LAMPY





# STOLNÍ LAMPY

## STOLNÉ LAMPY

LED

VIVA  
A+

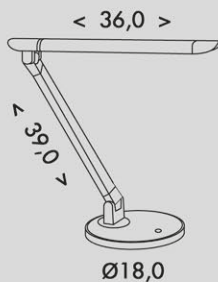

LTZ03-BI



LTZ03-CR

LTZ03-BI



LTZ03-CR

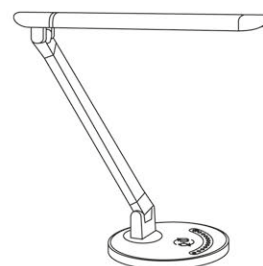

Možnosť stmívania a zmeny farby svetla.  
Možnosť stmievania a zmeny farby svetla.





## STOLNÍ LAMPY

### STOLNÉ LAMPY

LED

SARA

A+

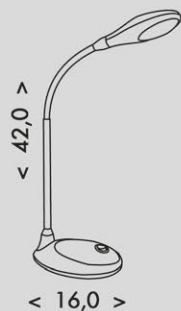

310lm



LS1009S-CR

310lm



LS1009S-CV

310lm



LS1009S-MO

LS1009S-CR



8 590 849 15 239 28

LS1009S-CV



8 590 849 15 239 42

LS1009S-MO



8 590 849 15 239 66



LED

KIRA

A+

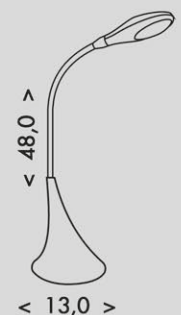
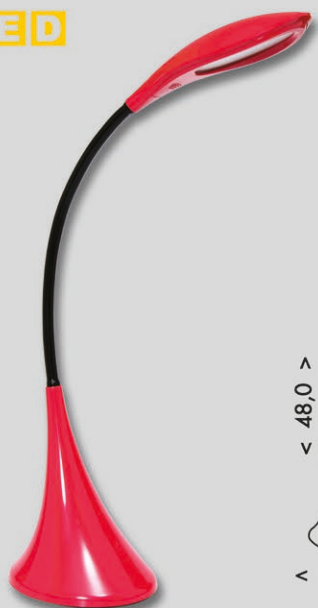

330lm



LS1011-CV

330lm



LS1011-MO

LS1011-CV



8 590 849 15 240 24

LS1011-MO



8 590 849 15 240 48





LED

MATRIX

A+



600lm



LBL1207-BI

600lm



LBL1207-CR

600lm



LBL1207-STR

LBL1207-BI



LBL1207-CR



LBL1207-STR



NOVINKA

LED

SPEKTRA

A+



630lm



L460-LED/CR

630lm



L460-LED/STR

L460-LED/CR



L460-LED/STR



NOVINKA

LED

ADEPT

A+



630lm



L50164-LED/BI

630lm



L50164-LED/STR

630lm



L50164-LED/CR

+



L50164-LED/BI



L50164-LED/CR



L50164-LED/STR





# STOLNÍ LAMPY

## STOLNÉ LAMPY

TINA

A - D

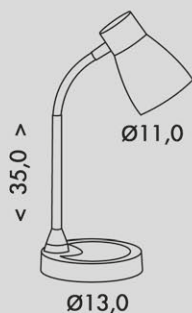

L2705-MO



L2705-STR



L2705-ORA



L2705-ZE



L2705-RUZ



L2705-ZLU

L2705-MO



L2705-STR



L2705-ORA



L2705-ZE



L2705-RUZ



L2705-ZLU



BOND

A - D

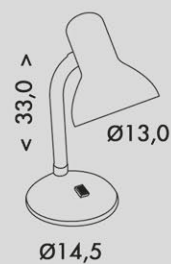

L077-BI



L077-MO



L077-CR



L077-STR



L077-CV



L077-MIX

L077-BI



L077-MO



L077-CR



L077M-STR



L077-CV



L077-MIX



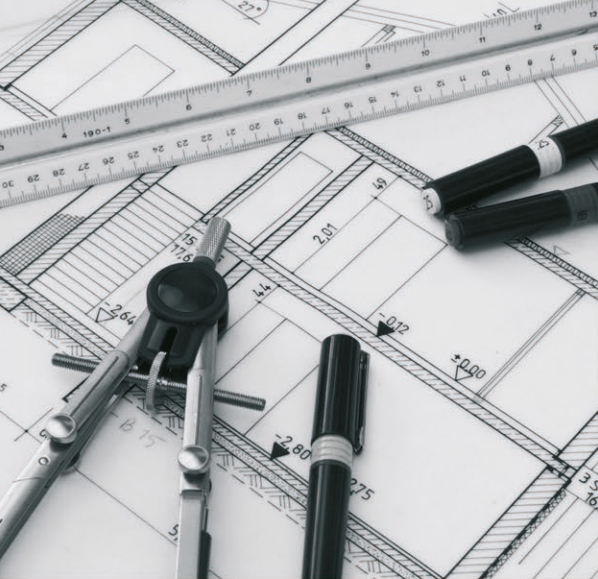

# STOLNÍ LAMPY

## STOLNÉ LAMPY

■ PLEXI

A - D

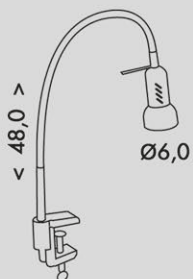

L078-BI



L078-CR

L078-BI



85908494078008

L078-CR



85908494078015





STOJACÍ LAMPY  
STOJANOVÉ LAMPY





## STOJACÍ LAMPY STOJANOVÉ LAMPY

DUHA

A - D



Ø28,5

< 177,0 >

Ø23,0



LF34-BI/CHRM



LF34-MO/CHRM

LF34-BI/CHRM



8 590 849 490190

LF34-MO/CHRM



8 590 849 490213





## STOJACÍ LAMPY

### STOJANOVÉ LAMPY

DUHA

A - D

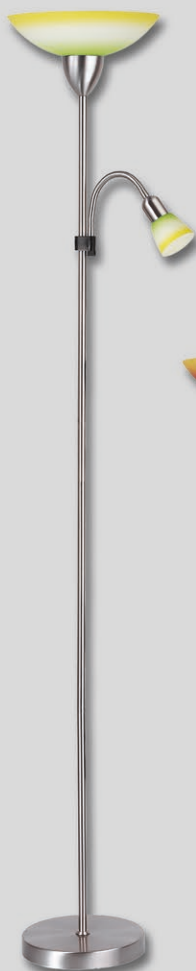

LF34-ZLU/CHR

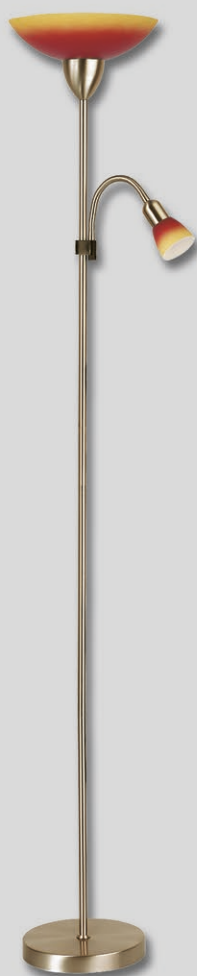

LF34-ORA/PAT

Ø28,5

< 177,0 >

Ø23,0

LF34-ZLU/CHR



8590849490220

LF34-ORA/PAT



8590849490206





VENKOVNÍ SVĚTLA  
VONKAJŠIE SVETLÁ





# VENKOVNÍ SVĚTLA

## VONKAJŠIE SVETLÁ

NOVINKA

NOVA

A - D

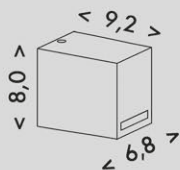

Z37AS-CR

Z37AS-CR



NOVINKA

NOVA

A - D

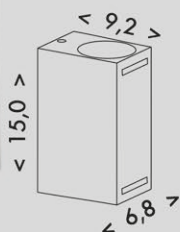

Z37AS-2/CR

Z37AS-2/CR





# VENKOVNÍ SVĚTLA

## VONKAJŠIE SVETLÁ

NOVINKA

NOVA 2

A - D

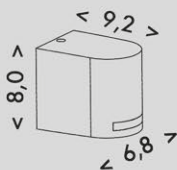

Z37AW-CR

Z37AW-CR



NOVINKA

NOVA 2

A - D

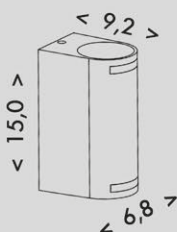

Z37AW-2/CR

Z37AW-2/CR







## VENKOVNÍ SVĚTLA VONKAJŠIE SVETLÁ

NOVINKA  
LED

STYL  
A+

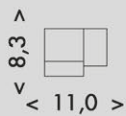

8W 500lm



Z1107-SED

8W 500lm



Z1107-CR

Z1107-SED



Z1107-CR



NOVINKA  
LED

STYL  
A+

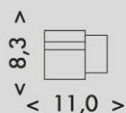
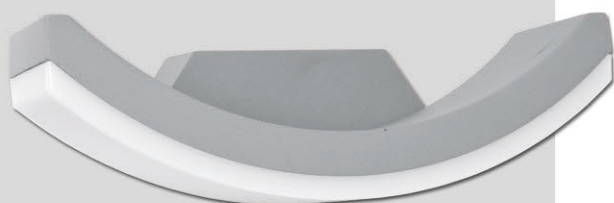

8W 540lm



Z1108-SED

8W 540lm



Z1108-CR

Z1108-SED



Z1108-CR





# VENKOVNÍ SVĚTLA

## VONKAJŠIE SVETLÁ

NOVINKA  
LED

STYL 2  
A+



8W 500lm

Z1107/PIR-SED



8W 500lm

Z1107/PIR-CR

Z1107/PIR-SED



85908494527834

Z1107/PIR-CR



85908494527810

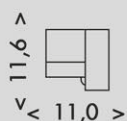



# VENKOVNÍ SVĚTLA

## VONKAJŠIE SVETLÁ

NOVINKA  
LED

STEP  
A+

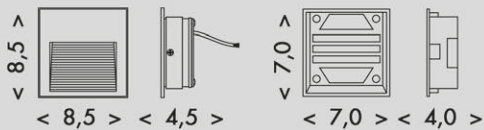
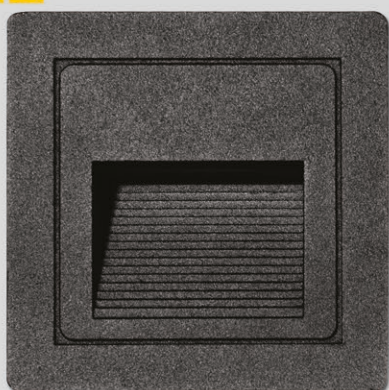

3W 270lm



Z01WF-CR

Z01WF-CR



3W 270lm



Z01WF-SED

Z01WF-SED

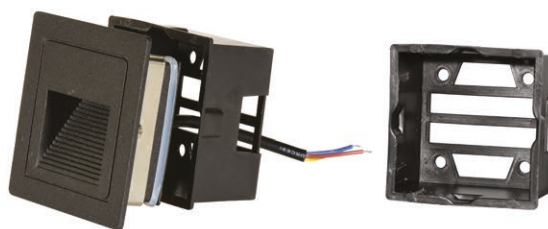

NOVINKA  
LED

STEP 2  
A+

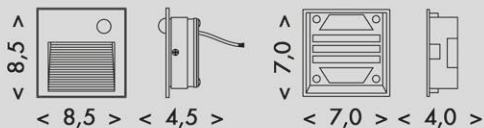

3W 270lm



Z01WF/PIR-CR

Z01WF/PIR-CR



3W 270lm



Z01WF/PIR-SED

Z01WF/PIR-SED

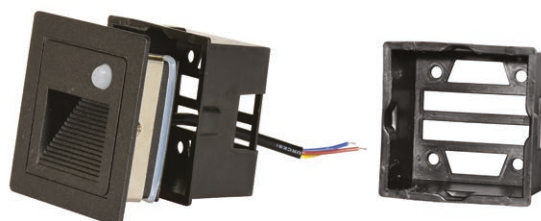





## VENKOVNÍ SVĚTLA

### VONKAJŠIE SVETLÁ

ANIS  
A - D



Z3019S-CHRM

Z3019S-CHRM



815908494520811



< 10,5 >





## VENKOVNÍ SVĚTLA VONKAJŠIE SVETLÁ



Z6101-CR



Z6101-PAT

Z6101-CR



Z6101-PAT



Z6102-CR



Z6102-PAT

Z6102-CR



Z6102-PAT





## VENKOVNÍ SVĚTLA

### VONKAJŠIE SVETLÁ



KLASIK

A - D

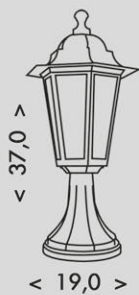

Z6104-CR



Z6104-PAT

Z6104-CR



Z6104-PAT



KLASIK

A - D



Z6105-CR



Z6105-PAT

Z6105-CR



Z6105-PAT







# VENKOVNÍ SVĚTLA

## VONKAJŠIE SVETLÁ

LAURA  
A - D



Z1503S-BI



Z1503S-CR

Z1503S-BI



Z1503S-CR

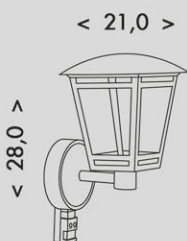

	značka shody s předpisy EU značka zhody s predpismi EU znak bezpieczeństwa zgodny dyrektywą unijną		halogenová žárovka JDR; závit E14 halogénová žiarovka JDR; závit E14 halogenowa żarówka JDR; gwint E14
	střídavé napětí 230V striedavé napätie 230V napięcie zasilania 230V		halogenová žárovka GU10 halogénová žiarovka GU10 halogenowa żarówka GU 10
	napětí 12V napätie 12V napięcie 12V		halogenová žárovka MR16 halogénová žiarovka MR16 halogenowa żarówka MR16
	třída I ochrany před el. proudem-svítilno musí být uzemněno. trieda I ochrany pred el. prúdom-svietidlo musí byť uzemnené konieczność ochrony przed el. prądem-lampa musi być uziemiona		halogenová žárovka JC halogénová žiarovka JC halogenowa żarówka JC
	třída II ochrany před el. proudem-dvojitá izolace; není třeba uzemňovat trieda II ochrany pred el. prúdom-dvojitá izolácia; nie je treba uzemňovať klasa II ochrony przed el. prądem-podwójna izolacja, niepotrzeba uziemiać		halogenová žárovka G9 halogénová žiarovka G9 halogenowa żarówka G9
	třída III ochrany před el. proudem-nízkonapětové svítilno (SELV) trieda III ochrany pred el. prúdom-nízkonapätové svetidlo (SELV) klasa III ochrony przed el. prądem-nisko napięciowa lampa		halogenová dvoupatřicová lineární žárovka J - délka v mm halogénová dvojpäticová lineárna žiarovka J - dĺžka v mm żarnik halogenowy liniowy typu J w mm
	lze montovat na normálně hořlavé povrchy je možné montovať na normálne horľavé povrchy možna montować na łatwopalnym podłożu		metalhalogenidová dvoupatřicová lineární výbojka metalhalogenidová dvojpäticová lineárna výbojka metalhalogenidowa liniowa żarówka
	maximální povolený výkon použité žárovky maximálny povolený výkon použitej žiarovky maksymalna moc żarówki		metalhalogenidová jednopaticová lineární výbojka metalhalogenidová jednopäticová lineárna výbojka metalhalogenidowa liniowa żarówka
	maximální povolený jmenovitý proud maximálny povolený menovitý prúd maksymalny znamionowy prąd		světloemittující čip světloemittujúci čip chip emitujący światło
	určeno pro použití v interieru určené pre použitie v interiéri przeznaczono do użytku wewnątrz		světloemittující čipy pokryté vrstvou luminoforu světloemittujúci čipy pokryté vrstvou luminoforu chipy emitujące światło pokryte warstwą luminoforu
	určeno pro použití v exteriéru určené pre použitie v exteriéri przeznaczono do użytku na zewnątrz		nízkonapětová žárovka T-15 nízkonapätová žiarovka T-15 nisko napięciowa żarówka T-15
	určeno pro použití v interieru i exteriéru určené pre použitie v interiéri aj exteriéri przeznaczono do użytku zewnętrznego i wewnątrz		trubice s ultrafialovým světlem trubica s ultrafialowym światłem ultrafioletowa jarzeniówka
	minimální vzdálenost od osvětlovaného objektu minimálna vzdialenosť od osvetľovaného objektu minimalna odległość od świecącego obiektu		objímka E27 - velký závit objímka E27 - velký závit oprawka E27- duży gwint
	střední doba životnosti světelného zdroje udávaná v hodinách stredná doba životnosti svetelného zdroja udávaná v hodinách żywołność świetlnego źródła w godzinach		objímka E14 - malý závit objímka E14 - malý závit oprawka E14 - mały gwint
	barva světla (teplota chromatičnosti); jednotka kelvin; <3300K-teplé světlo, 3300-5300K-bílé světlo, >6400-denní světlo barva svetla (teplota chromatičnosti); jednotka kelvin; <3300K-teplé svetlo, 3300-5300K-biele svetlo, >6400-denné svetlo barwa światła; jednostka kelwin; < 3300K-ciepłe światło, 3300-5300K-białe światło, >6400 dzienne światło		objímka pro zářivkovou trubici T8 objímka pre žiarivkovú trubicu T8 oprawka jarzeniówki T8
	standardní žárovka štandardná žiarovka standartowa żarówka		objímka pro zářivkovou trubici T5 objímka pre žiarivkovú trubicu T5 oprawka jarzeniówki T5
	standardní žárovka s malou baňkou štandardná žiarovka s malou bankou standartowa żarówka z małą bańką		objímka pro jednopaticovou zářivku DZ objímka pre jednopäticovú žiarivku DZ oprawka jarzeniówki DZ
	standardní žárovka s malou baňkou štandardná žiarovka s malou bankou standartowa żarówka z małą bańką		objímka pro jednopaticovou halogenovou žárovku JC-G4 objímka pre jednopäticovú halogénovú žiarovku JC-G4 oprawka halogenowej żarówki JC-G4
	standardní žárovka ve tvaru svíčky štandardná žiarovka v tvare sviečky standartowa żarówka z bańką-świeczka		objímka pro jednopaticovou halogenovou žárovku JC-G5,3 objímka pre jednopäticovú halogénovú žiarovku JC-G5,3 oprawka halogenowej żarówki JC-G5,3



objímka pro jednopaticovou halogenovou žárovku JC-G6,35  
objímka pre jednopaticovú halogénovú žiarovku JC-G6,35  
oprawka halogenowej żarówki JC-G6,35



reflektorová žárovka R50 se závitem E14  
reflektorová žiarovka R50 so závitom E14  
reflektorowa żarówka R50 z gwintem E14



reflektorová žárovka R63 se závitem E27  
reflektorová žiarovka R63 so závitom E27  
reflektorowa żarówka R63 z gwintem E27



jednopaticová zářivková trubice DZ/PL  
jednopaticová žiarivková trubica DZ/PL  
jarzeniówka typu DZ/PL



dvoupaticová lineární zářivka T5-průměr 16mm  
dvojpäticová lineárna žiarivka T5-priemer 16mm  
jarzeniówka T5 - o średnicy 16 mm



dvoupaticová lineární zářivka T8-průměr 26mm  
dvojpäticová lineárna žiarivka T8-priemer 26mm  
jarzeniówka T8-o średnicy 26 mm



kompaktní zářivka s elektronickým předřadníkem  
kompaktná žiarivka s elektronickým predradníkom  
kompaktowa żarówka z elektronicznym zapłonem



objímka pro halogenovou žárovku GU10  
objímka pre halogénovú žiarovku GU10  
oprawka halogenowej żarówki G10



objímka pro halogenovou žárovku G9  
objímka pre halogénovú žiarovku G9  
oprawka halogenowej żarówki G9



objímka pro trubicovou halogenovou žárovku J  
objímka pre trubicovú halogénovú žiarovku J  
oprawka halogenowej żarówki J



objímka pro trubicovou metalhalogenidovou výbojku  
objímka pre trubicovú metalhalogenidovú výbojku  
oprawka metalhalogenowej żarówki Rx7s



objímka pro nízkonapětovou žárovku T-15  
objímka pre nízkonapätovú žiarovku T-15  
oprawka niskonapiciowej żarówki T15



světelný zdroj je součástí svítidla  
svetelný zdroj je súčasťou svietidla  
źródło światła w komplecie



balení - počet kusů v kartonu  
balenie - počet kusov v kartóne  
opakowanie - ile sztuk w kartonie



součástí svítidla je elektronický předřadník  
súčasťou svietidla je elektronický predradník  
w wyposażeniu lampy jest elektroniczny starterem



součástí svítidla je indukční předřadník se startérem  
súčasťou svietidla je indukčný predradník so štartérom  
w wyposażeniu lampy jest starter indukcyjny



lze použít standardní žárovku nebo kompaktní zářivku  
je možné použiť štandardnú žiarovku alebo kompaktnú žiarivku  
używać standardowej lub kompaktowej żarówki



počet žil v kabelu x jejich průřez  
počet žil v kábli x ich prierez  
ilość i przekrój w mm kabla



halogenových žárovek se nedotýkejte holými rukama  
halogénových žiaroviek sa nedotýkajte holými rukami  
halogenowych żarówek nie dotykać gołymi rękami



maximální úhel detekce pohybového čidla  
maximálny uhol detekcie pohybového čidla  
maksymalny przechył



Infračervený pohybový senzor  
Infračervený pohybový senzor  
Czujnik ruchu podczerwieni



Vysokofrekvenční pohybový senzor  
Vysokofrekvenčný pohybový senzor  
Czujnik ruchu mikrofalowy



Index podání barev  
Index podania farieb  
Wskaźnik oddawania barw



Úhel rozptylu světla  
Uhol rozptylu svetla  
Kąt rozsyłu światła



součástí je akumulátor  
súčasťou je akumulátor  
akumulator



součástí svítidla je stmívač; světelný zdroj lze stmívat  
súčasťou svietidla je stmievač; svetelný zdroj je možné stmievat  
w urzadzeniu jest ściemniacz; lampa ze ściemniaczem



světelný zdroj není určen ke stmívání  
svetelný zdroj nie je určený na stmievanie  
lampę nie może pracować ze ściemniaczem



zapojení do zásuvky  
zapojenie do zásuvky  
włączyc do gniazdka



mechanická odolnost - stupeň ochrany krytem  
mechanická odolnosť - stupeň ochrany krytom  
odporność mechaniczna - stopień ochrony



určeno pro montáž na stěnu  
určené pre montáž na stenu  
przeznaczone do montazu na ścianie



určeno pro montáž na strop  
určené pre montáž na strop  
przeznaczone do montażu na suficie



určeno pro montáž na vodorovný pevný podklad  
určené pre montáž na vodorovný pevný podklad  
przeznaczone do montazu na równym podłożu



**Stupeň krytí IP**  
**Stupeň krytia IP**  
**Stopień ochrony IP**

- IP20** ochrana proti tělesům >12mm; bez ochrany proti vodě  
ochrana proti telesám >12mm; bez ochrany proti vode  
ochrona przed ciałami > 12 mm; bez ochrony przed wodą
- IP23** ochrana proti tělesům >12mm; chráněno proti vodě dopadajícím pod úhlem max 60°  
ochrana proti telesám >12mm; chránené proti vode dopadajúcej pod uhlom max 60°  
ochrona przed ciałami > 12mm; chroni przed padającymi kroplami po kątem max.60
- IP33** ochrana proti tělesům >2,5mm; chráněno proti vodě dopadajícím pod úhlem max 60°  
ochrana proti telesám >2,5mm; chránené proti vode dopadajúcej pod uhlom max 60°  
ochrona przed ciałami >2,5 mm; chroni przed padającymi kroplami po kątem max.60
- IP43** ochrana proti tělesům >1mm; chráněno proti vodě dopadajícím pod úhlem max 60°  
ochrana proti telesám >1mm; chránené proti vode dopadajúcej pod uhlom max 60°  
ochrona przed ciałami > 1mm; chroni przed padającymi kroplami po kątem max.60
- IP44** ochrana proti tělesům >1mm; chráněno proti stříkající vodě  
ochrana proti telesám >1mm; chránené proti striekajúcej vode  
ochrona przed ciałami > 1mm; chroni przed padającymi kroplami pod dowolnym kątem wody
- IP54** ochrana před prachem; chráněno proti stříkající vodě  
ochrana pred prachom; chránené proti striekajúcej vode  
ochrona przed pyłem; chroni przed padającymi kroplami pod dowolnym kątem wody
- IP65** prachotěsné; chráněno proti tryskající vodě  
prachotesné; chránené proti tryskajúcej vode  
ochrona pyłoszczelna; chroni przed bryzgami
- IP66** prachotěsné; chráněno proti silně tryskající vodě ze všech směrů  
prachotesné; chránené proti silne tryskajúcej vode zo všetkých smerov  
ochrona pyłoszczelna; chroni przed silnymi strumieniami wody ze wszystkich kierunków
- IP68** prachotěsné; ochrana proti účinkům trvalého ponoření.  
prachotesné; ochrana proti účinkom trvalého ponorenia  
ochrona pyłoszczelna; chroni w zanurzeniu

**Značky použitých materiálů**  
**Značky použitých materiálův**  
**Oznakowanie użytych materiałów**

- |   |  |  |   |
|---|--|--|---|
|  plast<br>plast<br>tworzywo    |  sklo<br>sklo<br>szkło            |  dřevo<br>drevo<br>drewno                 |  umělý kámen<br>umelý kameň<br>imitacja kamienia |
|  kov<br>kov<br>metal           |  keramika<br>keramika<br>ceramika |  proutí/bambus<br>prútie/bambus<br>bambus | <b>PS</b> transparentní polystyren<br>transparentný polystyren<br>transparent polystyren  |
|  hliník<br>hliník<br>aluminium |  látka<br>látka<br>tekstilia      |  papír<br>papier<br>papier                | <b>ABS</b> akrylonitrilbutadienstyren<br>akrylonitrilbutadienstyren<br>akrylonitrilbutadienstyren                                     |

**PC** polykarbonát s výbornými optickými vlastnostmi, velmi dobrou pevností a zvýšenou tepelnou odolností  
polykarbonát s výbornými optickými vlastnosťami, veľmi dobrou pevnosťou a zvýšenou tepelnou odolnosťou  
polykarbonat z bardzo dobrymi optycznymi własnościami, ze zwiększoną odpornością na temperaturę

**H05RR-F** pryžový kabel; pro použití ve venkovním prostředí  
pryžový kábel; pre použitie vo vonkajšom prostredí  
gumowy przewód; używać w zewnętrznych pomieszczeniach

**H05VV-F** kabel s plastovou izolací; pro použití v suchém prostředí  
kábel s plastovou izoláciou; pre použitie v suchom prostredí  
przewód w izolacji z tworzywa; używać w suchych pomieszczeniach

## UJIŠTĚNÍ O VYDÁNÍ EU PROHLÁŠENÍ O SHODĚ

**Dovozce:** Ecoplanet s.r.o.

**Sídlo:** Litoměřická 280/48  
418 01 Bílina  
Česká republika

**IČ:** 27278409

Potvrzujeme tímto, že pro námi distribuované výrobky, které jsou uvedeny na našich daňových dokladech a které jsou stanovenými výrobky dle zákona č. 22/1997 Sb., bylo vydáno EU prohlášení o shodě jejich vlastností s požadavky technických předpisů.

**Námi dovážené výrobky odpovídají požadavkům těchto dokumentů:**

<b>Dokument č.</b>	<b>Název</b>
2014/35/EU (LVD)	SMĚRNICE EVROPSKÉHO PARLAMENTU A RADY 2014/35/EU ze dne 26. února 2014 o harmonizaci právních předpisů členských států týkajících se dodávání elektrických zařízení určených pro používání v určitých mezích napětí na trh (přepracované znění).
2014/30/EU (EMC)	SMĚRNICE EVROPSKÉHO PARLAMENTU A RADY 2014/30/EU ze dne 26. února 2014 o harmonizaci právních předpisů členských států týkajících se elektromagnetické kompatibility (přepracované znění).
2011/65/EU (ROHS)	SMĚRNICE EVROPSKÉHO PARLAMENTU A RADY 2011/65/EU ze dne 8. června 2011 o omezení používání některých nebezpečných látek v elektrických a elektronických zařízeních a v souladu s požadavky uvedeného nařízení vlády a požadavky uvedené směrnice jsou také dodávány na trh.
2014/53/EU (RED)	SMĚRNICE 2014/53/EU EVROPSKÉHO PARLAMENTU A RADY ze dne 16. dubna 2014 o harmonizaci právních předpisů členských států týkajících se dodávání rádiových zařízení na trh a zrušení směrnice 1999/5/ES.

**Místo vydání:** Bílina

**Datum vydání:** 1.6.2016

**Jméno:** Ing. Lumír Füllsack

**Funkce:** jednatel

 **Ecoplanet** s.r.o.  
Litoměřická 280/48, 418 01 Bílina  
DIČ: CZ27278409 [www.ecoplanet.cz](http://www.ecoplanet.cz)

# NOVÁ KORPORÁTNÍ IDENTITA

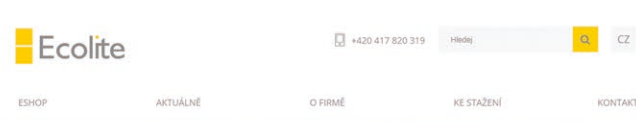

## KATEGORIE PRODUKTŮ





# DIAGNOSTIKA+ SVĚTELNÁ LABORATOŘ



Ecoplanet disponuje vlastní laboratoří, která je v rámci výrobního i předprodejního procesu klíčovým článkem ke kontrole a udržení kvality nabízených produktů.

Diagnostiku všech typů svítidel provádíme pomocí goniofotometru, kulového integrátoru a samostatných spektrometrů. Všechny přístroje jsou kalibrované a spolehlivě změří důležité elektrické i fotometrické veličiny.

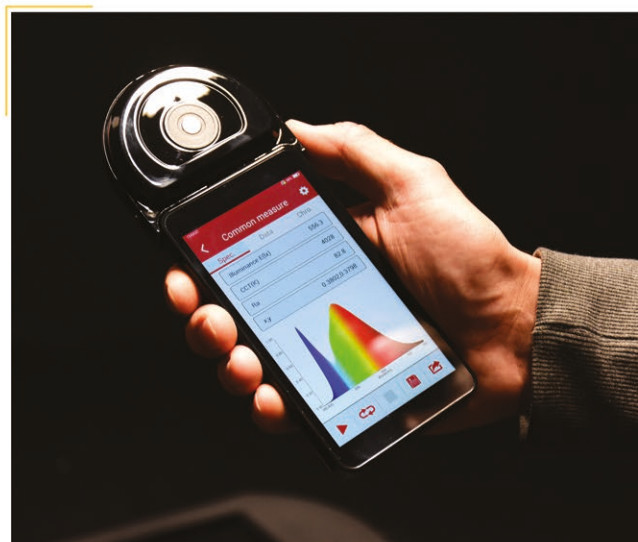

Kontrolu parametrů svítidel a měření křivek svítivosti v temné místnosti současně nabízíme jako zpoplatněnou službu zákazníkům. Výsledkem je protokol o měření a křivky ve formátu .ldt nebo .ies, které následně slouží k výpočtům osvětlení v odborných programech.

# DIAGNOSTIKA+ VÝPOČTY UMĚLÉHO OSVĚTLENÍ

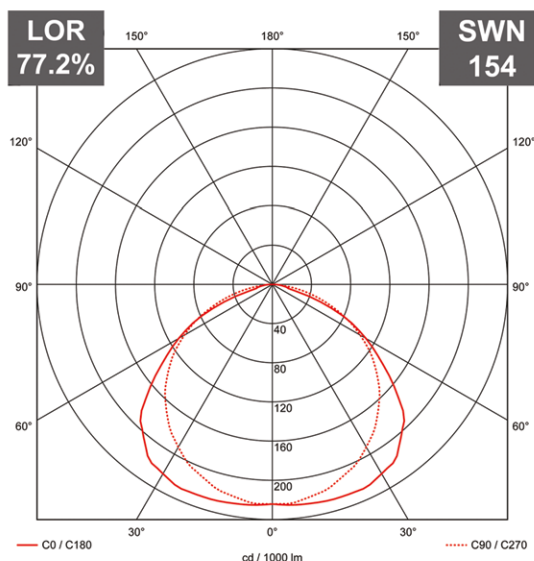

## SVÍTIDLO, PŮDORYS A POŽADAVKY

Zvolte si pro váš projekt jedno z našich svítidel nebo si jej nechte doporučit. Po odeslání specifikace místnosti (účel, půdorys) a požadavků vám pomocí fotometrických dat poskytneme výpočet osvětlení a vypracujeme kalkulaci na míru.

K výpočtům osvětlení používáme vlastní křivky svítivosti ve formátu .ldt nebo .ies, které generujeme v temné místnosti pomocí vlastního goniofotometru od renomovaného výrobce. Výstup pro váš projekt vám zašleme ve formátu PDF.

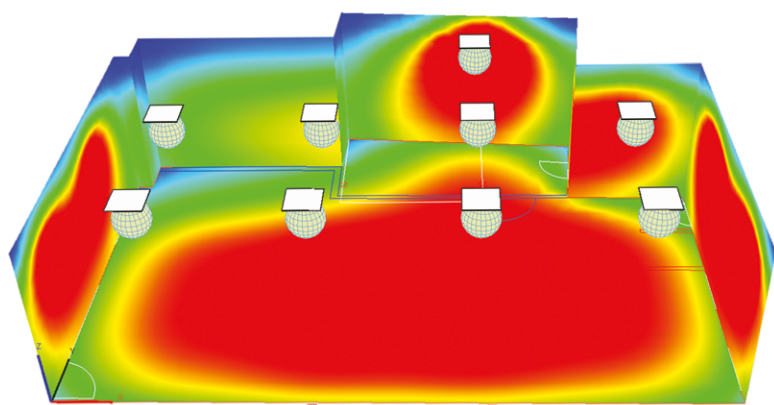
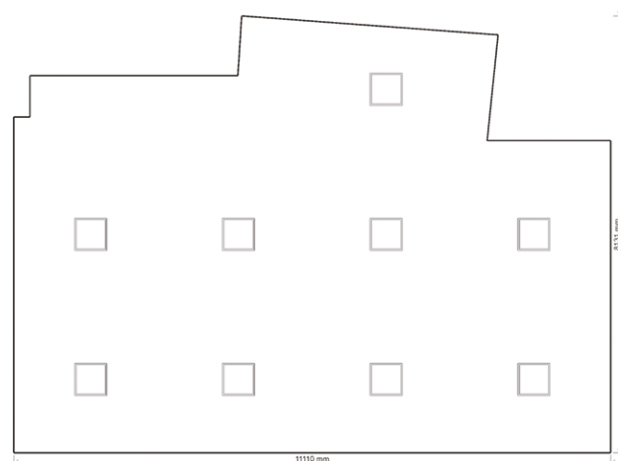

Součástí výpočtu je vizualizace osvětlených prostorů, informace o svítidle a doporučení na osvětlenost včetně činitele oslnění UGR dle platných norem ČSN.







[www.ecolite.cz](http://www.ecolite.cz)  
[www.ecolite.eu](http://www.ecolite.eu)  
[www.ecolite.sk](http://www.ecolite.sk)

sídlo:

Ecoplanet s. r. o.  
Litoměřická 280/48  
418 01 Bílina

sklad:

Hrobčice č.p. 76  
417 57 Hrobčice  
tel.: +420 602 529 835  
[objednavky@ecoplanet.cz](mailto:objednavky@ecoplanet.cz)



[www.ecolite.cz](http://www.ecolite.cz)